

Agilent 2000 X-Series Oscilloscopes

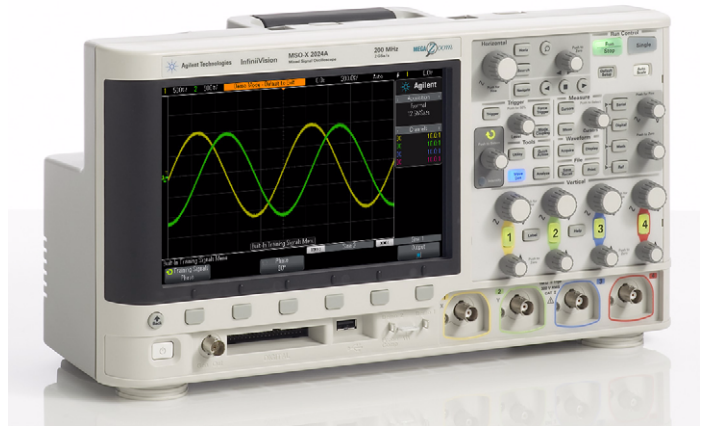

Advanced Training Guide

Lab guide and tutorial for making advanced oscilloscope measurements using an Agilent 2000 X-Series oscilloscope with the DSOXEDK training kit.



Agilent Technologies

Notices

© Agilent Technologies, Inc. 2008-2013

The copyright on this instructional material grants you permission to reprint, modify, and distribute in whole or in part the document for the purpose of training on Agilent test equipment.

Manual Part Number

75010-97012

Edition

April 5, 2013

Available in electronic format only

Agilent Technologies, Inc.
1900 Garden of the Gods Road
Colorado Springs, CO 80907 USA

Warranty

The material contained in this document is provided “as is,” and is subject to being changed, without notice, in future editions. Further, to the maximum extent permitted by applicable law, Agilent disclaims all warranties, either express or implied, with regard to this manual and any information contained herein, including but not limited to the implied warranties of merchantability and fitness for a particular purpose. Agilent shall not be liable for errors or for incidental or consequential damages in connection with the furnishing, use, or performance of this document or of any information contained herein. Should Agilent and the user have a separate written agreement with warranty terms covering the material in this document that conflict with these terms, the warranty terms in the separate agreement shall control.

Technology Licenses

The hardware and/or software described in this document are furnished under a license and may be used or copied only in accordance with the terms of such license.

Restricted Rights Legend

If software is for use in the performance of a U.S. Government prime contract or sub-contract, Software is delivered and licensed as “Commercial computer software” as defined in DFAR 252.227-7014 (June 1995), or as a “commercial item” as defined in FAR 2.101(a) or as “Restricted computer software” as defined in FAR 52.227-19 (June 1987) or any equivalent

agency regulation or contract clause. Use, duplication or disclosure of Software is subject to Agilent Technologies’ standard commercial license terms, and non-DOD Departments and Agencies of the U.S. Government will receive no greater than Restricted Rights as defined in FAR 52.227-19(c)(1-2) (June 1987). U.S. Government users will receive no greater than Limited Rights as defined in FAR 52.227-14 (June 1987) or DFAR 252.227-7015 (b)(2) (November 1995), as applicable in any technical data.

Safety Notices

CAUTION

A **CAUTION** notice denotes a hazard. It calls attention to an operating procedure, practice, or the like that, if not correctly performed or adhered to, could result in damage to the product or loss of important data. Do not proceed beyond a **CAUTION** notice until the indicated conditions are fully understood and met.

WARNING

A **WARNING** notice denotes a hazard. It calls attention to an operating procedure, practice, or the like that, if not correctly performed or adhered to, could result in personal injury or death. Do not proceed beyond a **WARNING** notice until the indicated conditions are fully understood and met.

Contents

1 Getting Started

Lab Guide—At a Glance	5
Front Panel Overview	6
Run Control	7
Waveform Controls	7
Horizontal Controls	8
Vertical Controls	9
Trigger Controls	9
Tools Controls	10

2 Oscilloscope Familiarization Labs

Lab #1: Using Cursors and Automatic Parametric Measurements	12
Lab #2: Using Zoom Display to Perform Gated Measurements	19
Lab #3: Using Waveform Math	23
Lab #4: Using Peak Detect Acquisition Mode	27
Lab #5: Using Segmented Memory Acquisition Mode	30
Lab #6: Using Mask Test	35

3 Advanced Triggering, Search & Navigation, and Segmented Acquisition Labs

Lab #7: Triggering on a Digital Burst using Trigger Holdoff	40
Lab #8: Triggering on Unique Pulses and Glitches using “Pulse-width” Trigger	44
Lab #9: Triggering on Logic Patterns using the MSO’s Digital Channels	48

4 Serial Bus Decoding & Triggering, Search & Navigation, and Segmented Acquisition Labs

Lab #10: Decoding, Triggering, and Searching on I ² C Serial Bus Signals	54
Lab #11: Decoding, Triggering, and Searching on SPI Serial Bus Signals	61
Lab #12: Decoding, Triggering, and Searching on RS232/UART Serial Bus Signals	67
Lab #13: Decoding, Triggering, and Searching on CAN Serial Bus Signals	75
Lab #14: Decoding, Triggering, and Searching on LIN Serial Bus Signals	81

A Oscilloscope Block Diagram and Theory of Operation

DSO Block Diagram	88
ADC Block	88
Attenuator Block	89
DC Offset Block	89
Amplifier Block	89
Trigger Comparator and Trigger Logic Blocks	90
Timebase and Acquisition Memory Blocks	90
Display DSP Block	91

B Oscilloscope Bandwidth Tutorial

Defining Oscilloscope Bandwidth	93
Required Bandwidth for Analog Applications	94
Required Bandwidth for Digital Applications	95
Rule of Thumb	95
Step 1: Determine fastest actual edge speeds	96
Step 2: Calculate f_{knee}	96
Step 3: Calculate scope bandwidth	96
Example	97
Digital Clock Measurement Comparisons	98

C Related Agilent Literature

Index

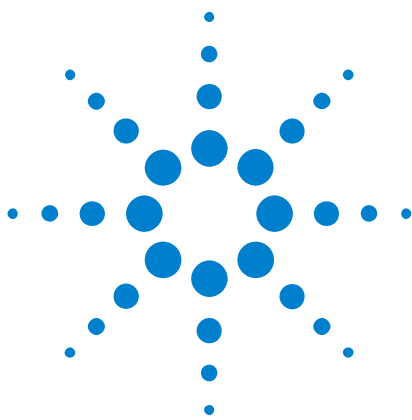

1 Getting Started

Lab Guide—At a Glance 5

Front Panel Overview 6

Lab Guide—At a Glance

This advanced oscilloscope training guide and tutorial is intended to be used with Agilent Technologies InfiniiVision 2000 X-Series oscilloscopes (DSO and MSO models) that are licensed with the Oscilloscope Education Training Kit (DSOXEDK). When licensed with this training kit, 2000 X-Series oscilloscopes are able to generate a broad range of built-in training signals.

The built-in training signals can be probed by simply connecting a standard 10:1 passive probe between channel-1's input BNC and the front panel terminal labeled "Demo 1", and another probe between channel-2's input BNC and the terminal labeled "Demo 2" as shown on the next page.

To turn on specific training signals for each of the labs documented in this training guide, simply:

- 1 Press the scope's front panel **[Help]** key.
- 2 Press the **Training Signals** sofkey.
- 3 Turn the  Entry knob to select the appropriate training signal.
- 4 Press the **Output** softkey to enable the training signal output on the Demo terminal(s).



1 Getting Started

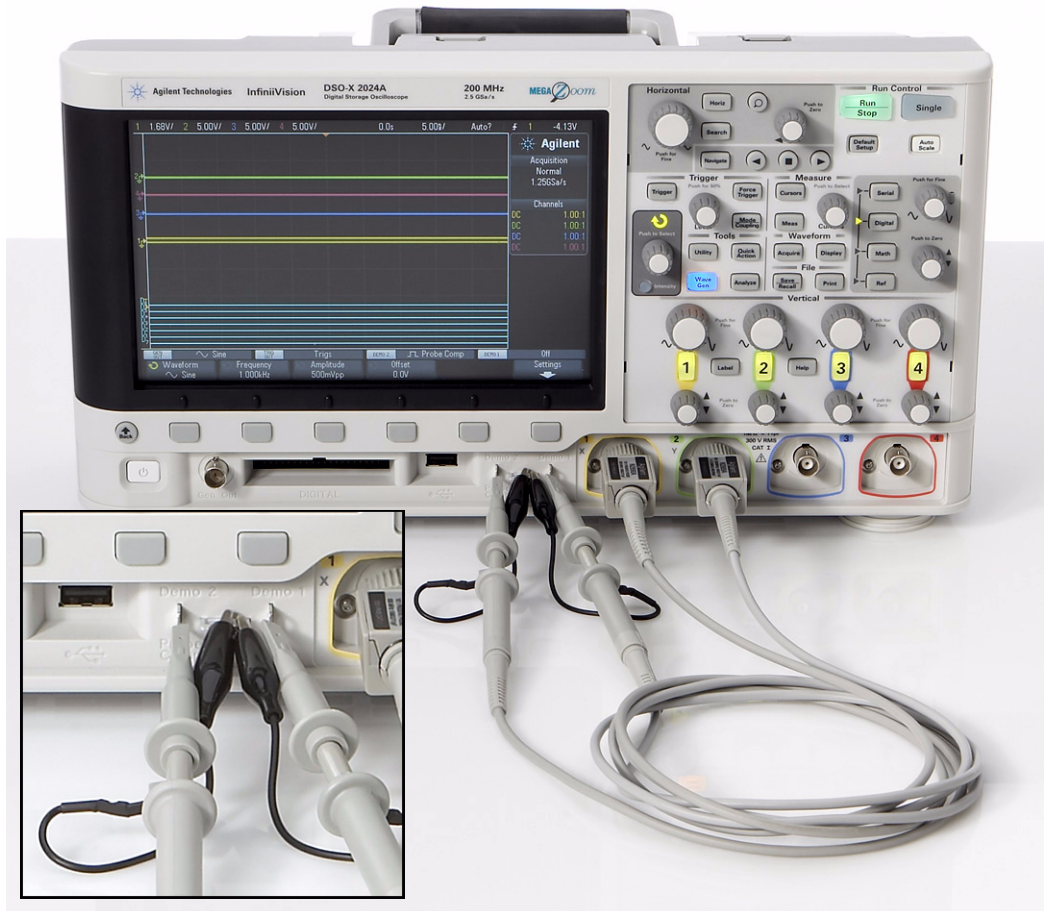

If you are not familiar with the Agilent InfiniiVision 2000 X-Series oscilloscope, first look over the main sections of the front panel as illustrated on the following pages, and then begin with [Chapter 2](#), “Oscilloscope Familiarization Labs,” starting on page 11.

Once you have become familiar with using the basic functions of the oscilloscope, you can then skip to particular labs of interest. Each hands-on lab can be considered as a standalone lab exercise because each begins with a default setup. In other words, successive labs do not build on the previous lab. They can be completed in any order of preference.

Front Panel Overview

For instant help on any topic, press and hold any key, softkey, or knob.

Run Control

When the oscilloscope is turned on, or if **[Auto Scale]** is pressed, the acquisition will be set to **[Run]**. At any time you may **[Stop]** the acquisition process to examine a signal in detail or to save it.

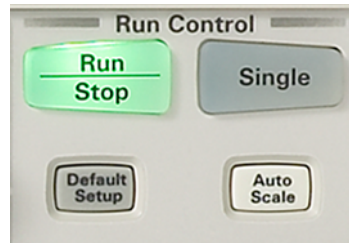

- The **[Default Setup]** key on the front panel sets the oscilloscope to the default configuration.

Because the oscilloscope may have been used in a variety of applications by a variety of people, it is a good measurement procedure to put the oscilloscope in a known starting mode (Default Setup). This makes it easy to duplicate measurements because no special conditions are set.

- The **[Auto Scale]** key on the front panel automatically configures the oscilloscope by analyzing all active channels, turning them on and setting the timebase, V/div, and trigger conditions for an initial display.
- Press the **[Single]** key to make a single acquisition and stop the acquisition process.

Waveform Controls

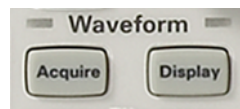

- The **[Acquire]** key on the front panel lets you set the oscilloscope data acquisition modes.
- The **[Display]** key on the front panel lets you set the waveform persistence options and the grid type and grid intensity.

1 Getting Started

- The [**Intensity**] key and the  Entry knob lets you set the desired signal brightness.



Horizontal Controls



- a Turn the large knob in the Horizontal control section clockwise and counter-clockwise to control the time/div setting of the horizontal axis.

Observe the changes in the displayed signal. The current timebase setting is displayed at the top of the display on the status line.

- b Turn the small knob in the horizontal control section to move the trigger point (solid orange triangle) from the reference point (hollow orange triangle).
- c Press the [**Horiz**] key to display the Horizontal menu. Note the various Time Modes of **Normal**, **Roll**, and **XY**. Also notice the **Zoom** mode softkey.
- d Press the  (zoom) key to quickly turn on the zoom mode. This split-screen mode shows the big picture on top and an expanded view on the bottom. Turn the large timebase knob counter-clockwise to make the window on top larger.

Vertical Controls

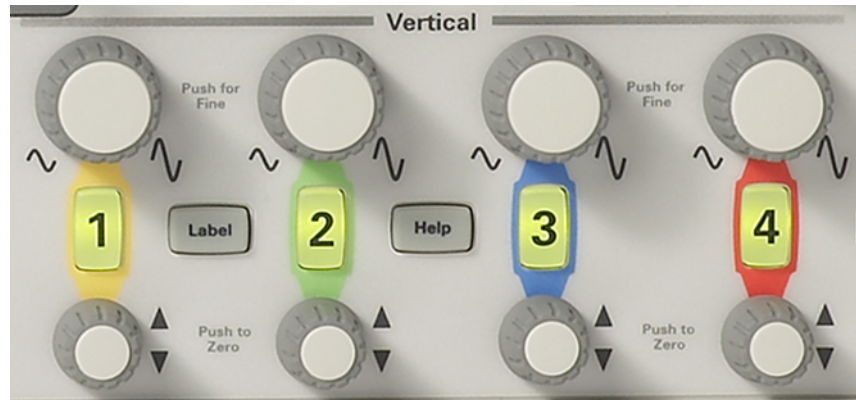

- Turn the **large knobs** in the Vertical section to control the V/div setting for each analog channel. The V/div setting is displayed in the upper left hand corner of the status line at the top of the display.

Color coding matches analog channel inputs, vertical control knobs, and waveform colors.

- Press the [1] key to display the channel 1 menu. Press again to turn the channel on and off.
- Turn the **small knobs** to control the vertical offset position of the waveform, moving the ground level up or down.

Trigger Controls



- Turn the **Trigger Level knob** to move the trigger level up and down. The trigger level is displayed while it is adjusted. If the trigger level is above or below the signal and the oscilloscope is in Auto trigger mode, the oscilloscope will force a trigger and display an acquisition (waveform).

Auto trigger mode is useful when unsure of the exact waveform because forced acquisitions are displayed, making it easy to better configure the oscilloscope's settings and trigger level.

- Press the [**Mode/Coupling**] key in the Trigger controls section to view the Trigger Mode and Coupling Menu selections and to set trigger holdoff.

1 Getting Started

- Press and hold the **Mode** softkey to read the built-in help about the **Auto** and **Normal** trigger modes.

Tools Controls



- Press the [**Utility**] key to access the I/O ports, file explorer, options, service information, and the “Quick Action” key function settings.
- Press the [**Quick Action**] key to perform one of the quick action functions that can be mapped to this key.
- Press the [**Analyze**] key to set trigger levels, measurement threshold levels, video trigger auto setup and display, or the mask testing application options.

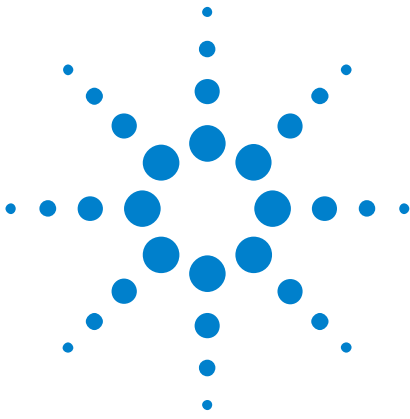

2 Oscilloscope Familiarization Labs

Lab #1: Using Cursors and Automatic Parametric Measurements 12

Lab #2: Using Zoom Display to Perform Gated Measurements 19

Lab #3: Using Waveform Math 23

Lab #4: Using Peak Detect Acquisition Mode 27

Lab #5: Using Segmented Memory Acquisition Mode 30

Lab #6: Using Mask Test 35



Lab #1: Using Cursors and Automatic Parametric Measurements

During this first hands-on lab, you will learn how to make simple voltage and timing measurements using the scope's manually positioned measurement cursors, as well as perform similar measurements using the scope's automatic parametric measurement capability.

- 1 Connect the channel-1 probe to the Demo 1 terminal and ground.
- 2 Press **[Default Setup]** on the scope's front panel.
- 3 Press **[Help]**; then press the **Training Signals** softkey.
- 4 Using the Entry knob, select the **Repetitive Pulse with Ringing** signal; then press the **Output** softkey to turn it on.
- 5 Set channel-1's V/div setting to **500 mV/div**.
- 6 Set channel-1's position/offset to **1.40 V**.
- 7 Push the trigger level knob to automatically set the trigger level at approximately **50%**.
- 8 Set the scope's timebase to **500.0 ns/div**.

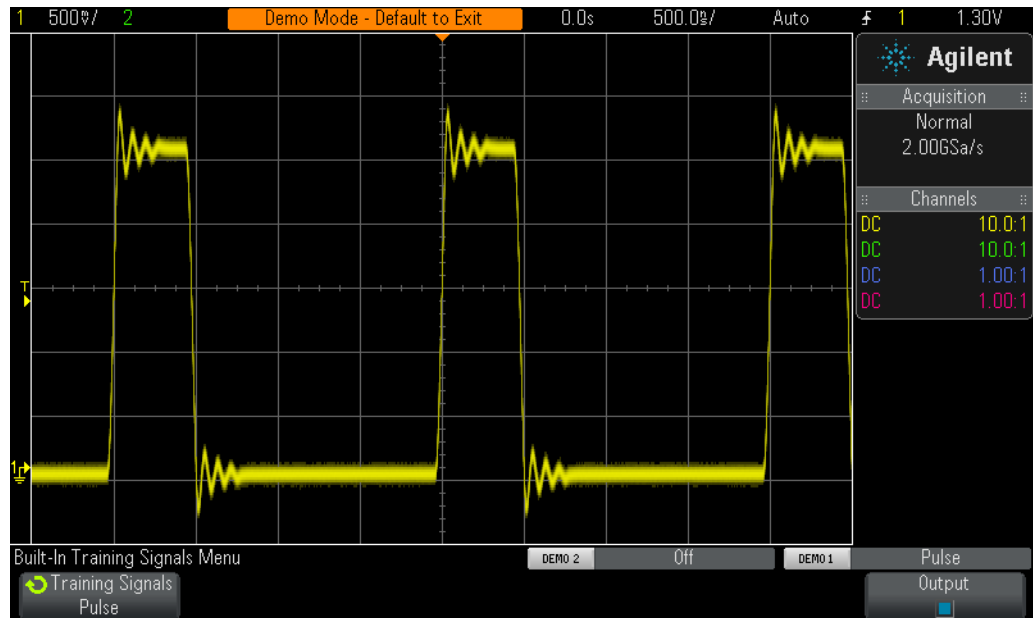

Figure 1 Oscilloscope setup to capture and display a repetitive digital pulse with ringing and overshoot.

At this point, you should see a repetitive digital pulse with overshoot and ringing similar to what is shown in [Figure 1](#). Note that all front panel knobs are pushable. If you push the V/div knob or time/div knob, you can toggle between course adjustment and fine adjustment (vernier control). When other knobs are pushed, the scope will pre-set conditions associated

with that particular knob. For instance, if you push one of the vertical position/offset knobs, offset will be set to 0.0 V for that input channel. If you push the horizontal position/delay knob, delay relative to trigger will be set to 0.0 seconds. If you push the trigger level knob, the scope will automatically set the trigger level to approximately 50%.



Figure 2 Measurement Cursors knob.

Let's now use the scope's "cursors" function to measure the positive pulse width and peak-to-peak voltage of this waveform. First, visually locate the "Cursors" knob in the **Measure** section of the front panel as shown in [Figure 2](#).

- 9 Push the **Cursors** knob; then rotate this knob until "X1" is highlighted; then press again to select (if you don't press the knob a second time after dialing to the "X1" cursor, a time-out will occur and then the X1 cursor will automatically be selected and the menu will close).
- 10 Turn the Cursors knob until the X1 cursor (#1 timing marker) intersects with a rising edge of the pulse.
- 11 Push the Cursors knob again; rotate this knob until "X2" is highlighted; then press again to select.
- 12 Turn the Cursors knob until the X2 cursor (#2 timing marker) intersects with the next falling edge of the same pulse.
- 13 Push the Cursors knob again; rotate this knob until "Y1" is highlighted; then press again to select.
- 14 Turn the Cursors knob until the Y1 cursor (#1 voltage marker) intersects with the negative peak of the pulse.
- 15 Push the Cursors knob again; rotate this knob until "Y2" is highlighted; then press again to select.
- 16 Turn the Cursors knob until the Y2 cursor (#2 voltage marker) intersects with the positive peak of the pulse.

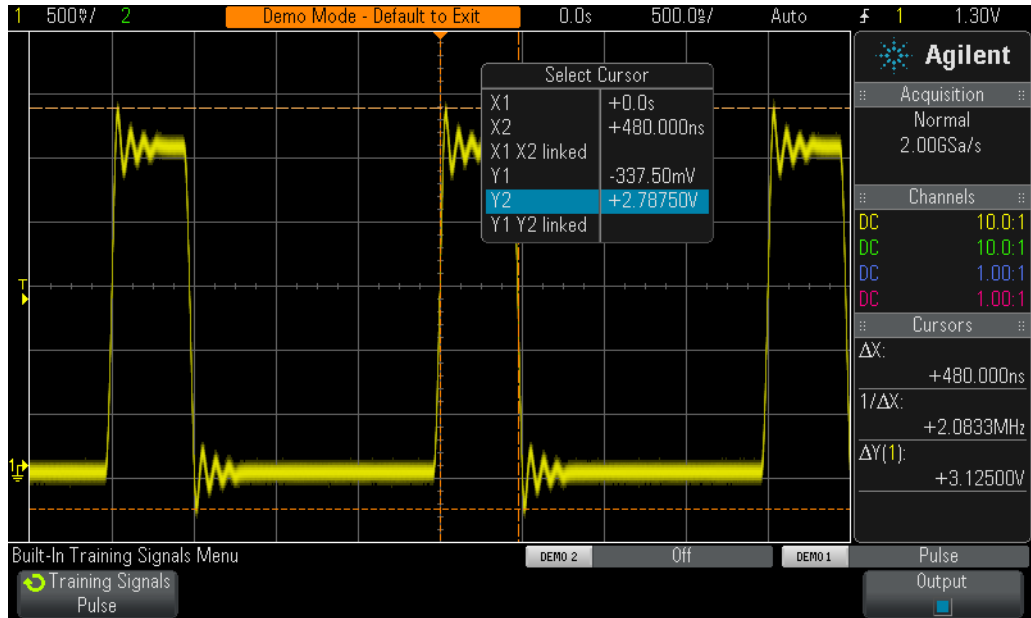

Figure 3 Using the scope’s cursor measurements.

Delta readouts are displayed on the right-hand side of the display. If you press the **[Cursors]** front panel key, you can see absolute voltage and time readouts for each cursor near the bottom of the display.

In addition to using the scope’s default “manual” placement of time and voltage cursors independently, you can also select the **Track Waveform** cursor mode by pressing the **[Cursors]** front panel key, and then change from “manual” to “tracking”. In the “tracking” cursor mode, you have the ability to control the time placement of the cursors, and then the scope will automatically position the voltage cursors on the waveform where the time cursors intersect the waveform.

Let’s now perform some automatic parametric measurements on this waveform.

17 Press the **[Meas]** front panel key (next to the Cursors knob).

If beginning with a default setup (as we have done), when the **[Meas]** key is pressed the scope will turn on an automatic frequency and Vp-p measurement. Because this scope is able to show up to four continuously updated measurements, let’s add two more measurements.

18 Press the **Type** softkey; then turn the Entry knob until the arrow points to **Maximum**.

19 Now either push the Entry knob to select this measurement, or press the **Add Measurement** softkey. Notice the level indicator that shows where this measurement is being performed.

- 20 Turn the Entry knob again until the arrow points to **Minimum**; then push the Entry knob.

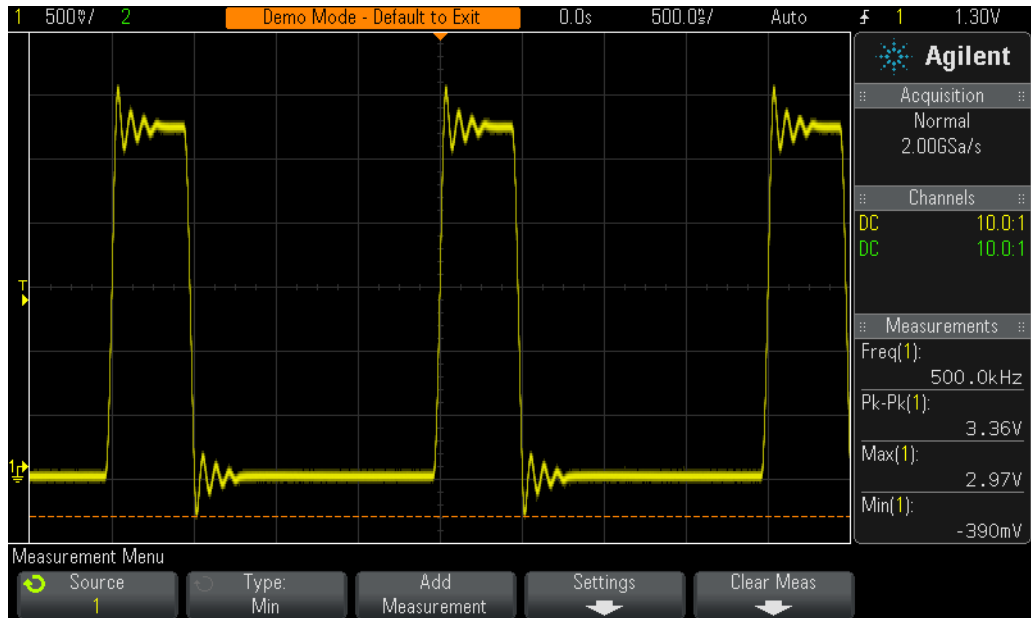

Figure 4 The scope automatically performs up to four parametric measurements.

Your scope's display should now look similar to [Figure 4](#) showing four continuously update measurements; Frequency, Vp-p, Vmax, and Vmin. Let's now perform four different measurements.

- 21 Press the **Clear Meas** softkey; then press the **Clear All** softkey.
- 22 Set the scope's timebase to **200.0 ns/div**. Expanding on the pulse will provide us with increased measurement resolution.
- 23 Now select to measure **Top**, **Base**, **Rise Time**, and **Fall Time**.

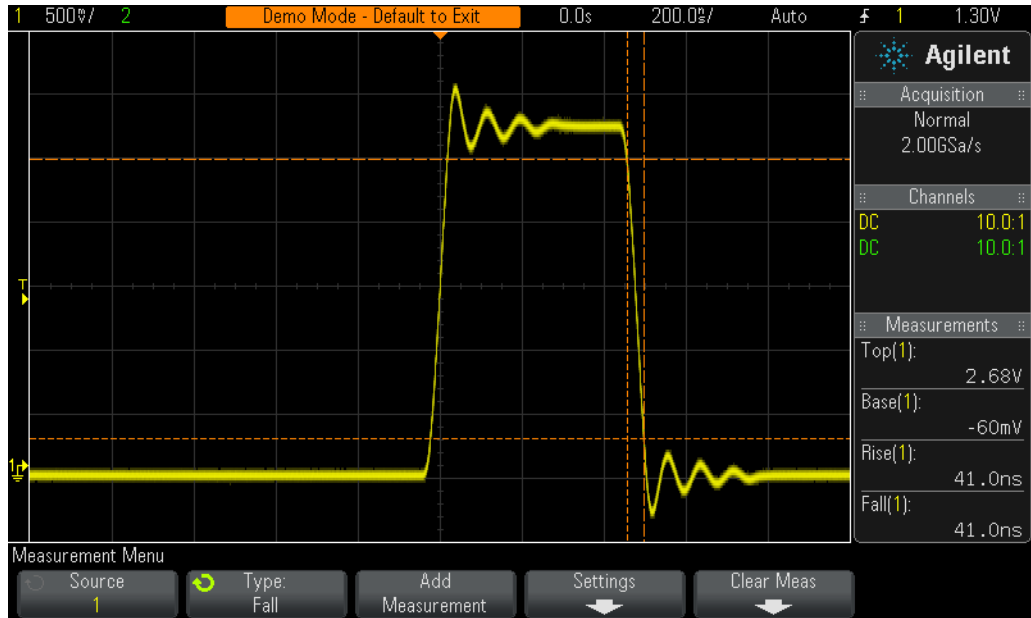

Figure 5 Performing additional pulse parameter measurements on a digital pulse.



Your scope’s display should now look similar to [Figure 5](#). If Fall Time was the last measurement that you selected, then the cursors will show where this measurement is being performed.

At this point, you may be wondering what the difference is between the “top” of a waveform (V_{top}) versus the “maximum” of a waveform (V_{max}), as well as the difference between the “base” of a waveform (V_{base}) versus the “minimum” of a waveform (V_{min}).

V_{top} is the steady-state high level of the waveform. This is the voltage level of the waveform after the overshoot and ringing have settled. Likewise, V_{base} is the steady-state low level of the waveform. For digital pulse parameter measurements, V_{top} and V_{base} are often more important parameters to measure than the absolute maximum and minimum voltages of the waveform (V_{max} and V_{min}), which are the peak values of the overshoot.

The Rise Time and Fall Time measurements that we performed are relative transition times. This means that they have been performed relative to specific voltage threshold levels. The scope’s default threshold levels for these measurements are the 10% and 90% levels relative to V_{base} and V_{top} . But many of today’s higher speed devices have specified rise and fall times relative to 20% and 80% threshold levels, or perhaps relative to absolute voltage levels, such as from/to ± 1.0 V. Let’s now set up our scope to measure just the rise time of this pulse relative to the 20% and 80% threshold levels.

24 Press the **Clear Meas** softkey; then press the **Clear All** softkey.

- 25 Press the **Settings** softkey; then press the **Thresholds** softkey.
- 26 Press the **Lower** softkey; then turn the Entry knob until it reads **20%**.
- 27 Press the **Upper** softkey; then turn the Entry knob until it reads **80%**.
- 28 To return to the previous menu, press the  (Back) front panel key (just above the power switch).
- 29 Press the  (Back) key again because we descended two levels into this menu.
- 30 Press the **Type** softkey; then turn the Entry knob until the arrow points to **Rise Time**.
- 31 Now either press the **Add Measurement** softkey, or push the Entry knob to add this measurement.

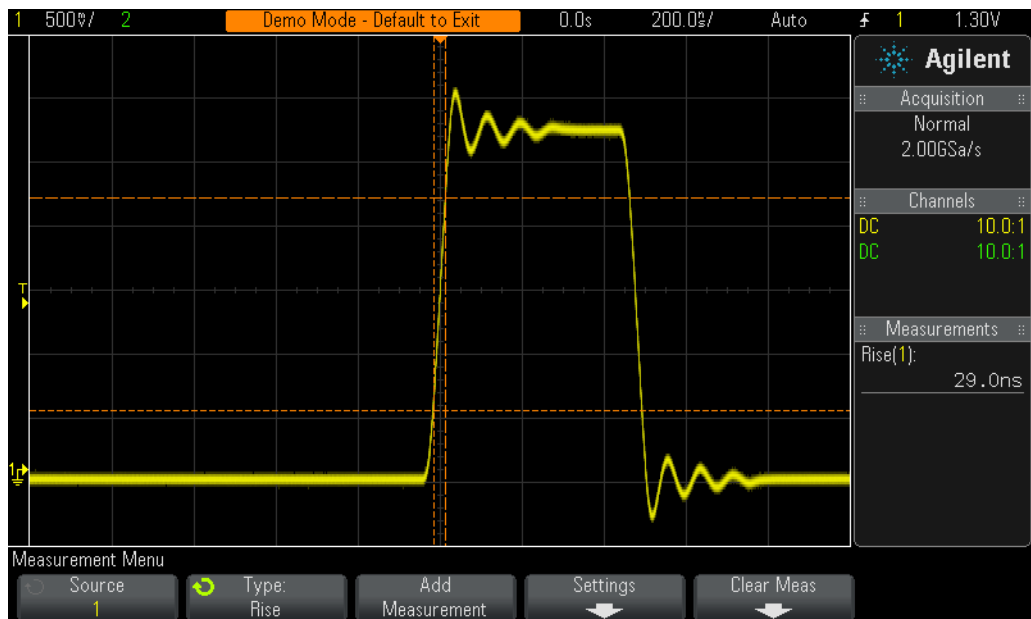

Figure 6 Performing a rise time measurement relative to 20% and 80% threshold levels.

Using these user-defined measurement threshold levels (20% and 80%), our rise time measurement should be faster because we are now measuring across a shorter segment of the waveform as shown in [Figure 6](#). The measurement should now read approximately 30 ns. When we used the scope's default 10%/90% threshold levels, the measurement should have read approximately 40 ns.

Let's now make one more measurement before completing this lab. But this time let's perform a more comprehensive set of measurements on this waveform.

- 32 Set the scope's timebase to **500.0 ns/div**.

- 33 Press the **Type** softkey; then turn the Entry knob until the arrow points to **Snapshot All** (top of the list).
- 34 Now either press the **Add Measurement** softkey, or push the Entry knob to add this set of measurements.



Figure 7 Performing a comprehensive set of automatic parametric measurements using the “Snapshot All” function.

The “Snapshot-All” measurement provides us with a one-time (snapshot) measurement of several parameters in order to completely characterize our input signal as shown in [Figure 7](#). Note that this set of measurements is not continuously updated, and if you press any front panel or softkey, the display of these measurements will disappear.

Lab #2: Using Zoom Display to Perform Gated Measurements

When performing automatic parametric measurements, such as positive pulse width measurements, on an exactly repetitive input signal, such as a simple sine wave or square wave, it really doesn't matter which particular pulse the scope chooses to make the measurement on; each pulse is the same. But what if the input signal you are probing is more complex; where each pulse has unique parametric characteristics? In this case, you would first need to set up the scope to trigger at a unique point in time on the complex signal, and then you would need to set up the scope's measurements in such a way that the scope would be more selective as to which pulse it chooses to perform measurements on. In this lab you will learn how to perform selective, or "gated", measurements on specific pulses using the scope's Zoom display mode.

- 1 Connect the channel-1 probe to the Demo 1 terminal and ground.
- 2 Press the **[Default Setup]** key on the scope's front panel.
- 3 Press **[Help]**; then press the **Training Signals** softkey.
- 4 Using the Entry knob, select the **Digital Burst with Infrequent Glitch** signal; then press the **Output** softkey to turn it on.
- 5 Set channel-1's V/div setting to **1.0 V/div**.
- 6 Set channel-1's position/offset setting to approximately **2.0 V** in order to center the waveform on-screen.
- 7 Push the trigger level knob in order to automatically set the trigger level at approximately **50%** (~1.7 V).
- 8 Set the scope's timebase to **1.000 μ s/div**.
- 9 Press the **[Mode/Coupling]** front panel key near the trigger level knob.
- 10 Press the **Holdoff** softkey; then turn the Entry knob clockwise to set the trigger holdoff value to **4.000 μ s**.

With the scope's trigger holdoff feature turned on and set to 4.0 μ s, the scope now triggers on the 1st rising edge of the burst, disarms triggering for 4.0 μ s, and then re-arms triggering after the last pulse in the burst so that the scope will again trigger on the 1st pulse during the next repetition of the burst. We have now established a stable and unique trigger point on this complex digital signal using Trigger Holdoff. You can learn more about Trigger Holdoff during "[Lab #7: Triggering on a Digital Burst using Trigger Holdoff](#)" on page 40.

2 Oscilloscope Familiarization Labs

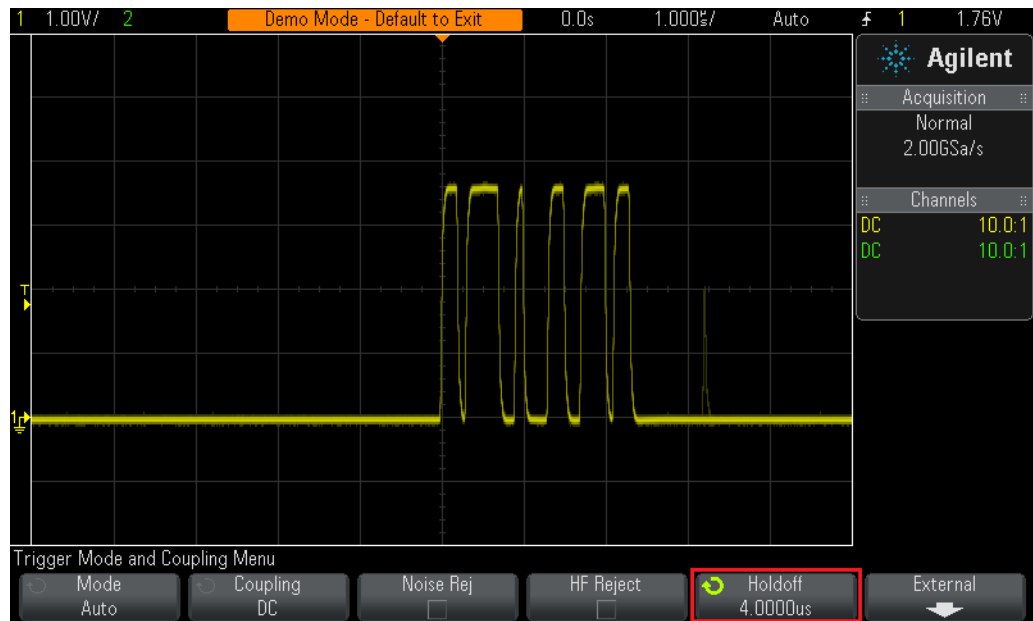

Figure 8 Setting up the oscilloscope to capture a burst of digital pulses with different pulse widths.

You should now observe 6 positive pulses with varying widths, plus an infrequent glitch occurring after the 6th pulse as shown in [Figure 8](#). Let's now turn on a "+ Width" measurement.

- 11 Press the **[Meas]** front panel key (next to the Cursors knob).
- 12 Press the **Clear Meas** softkey; then press the **Clear All** softkey.
- 13 Press the **Type** softkey; then select the **+ Width** measurement using the Entry knob.
- 14 Either push the Entry knob or press the **Add Measurement** softkey to select this measurement.

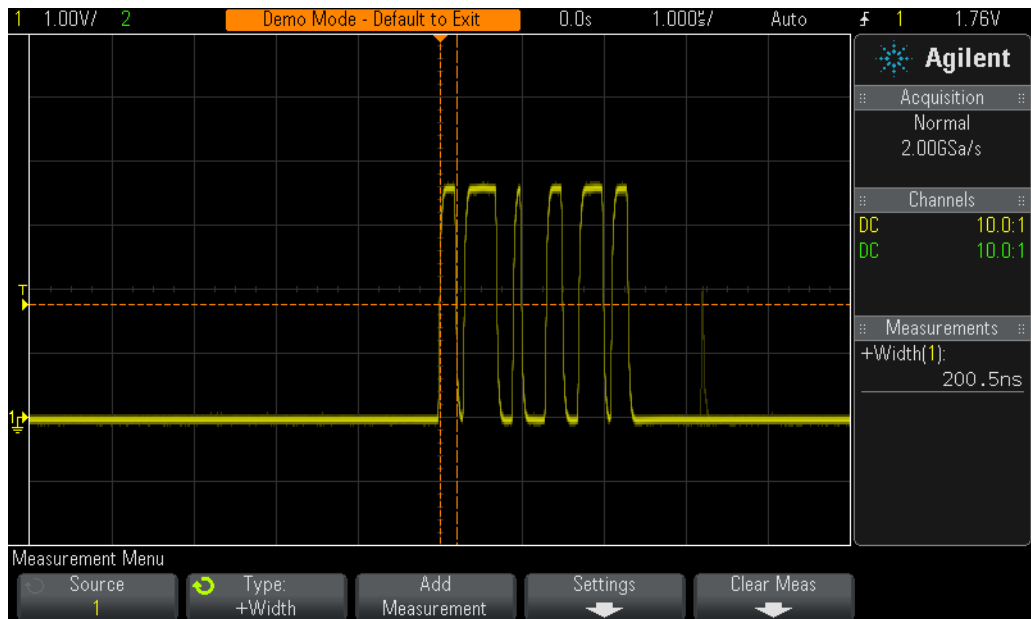



Figure 9 Measuring the positive pulse width of the 1st pulse in the burst.

The scope always performs measurements on the pulse located closest to center-screen. In this case, the scope measures the positive pulse width of the 1st pulse in this digital burst as shown in [Figure 9](#). But what if we want to know the widths of the 2nd, 3rd, 4th, etc., pulses?

- 15 Press the  button in the Horizontal section of the front panel to turn on the scope's "zoom" display mode.
- 16 Set the Zoom timebase to **50.00 ns/div** by turning the large timebase knob.
- 17 Set the horizontal position/delay to **950.0 ns** in order to window-in on the 3rd pulse.

When the "zoom" display is turned on, the horizontal controls (s/div and position) control the zoomed (or expanded) timebase settings.

2 Oscilloscope Familiarization Labs

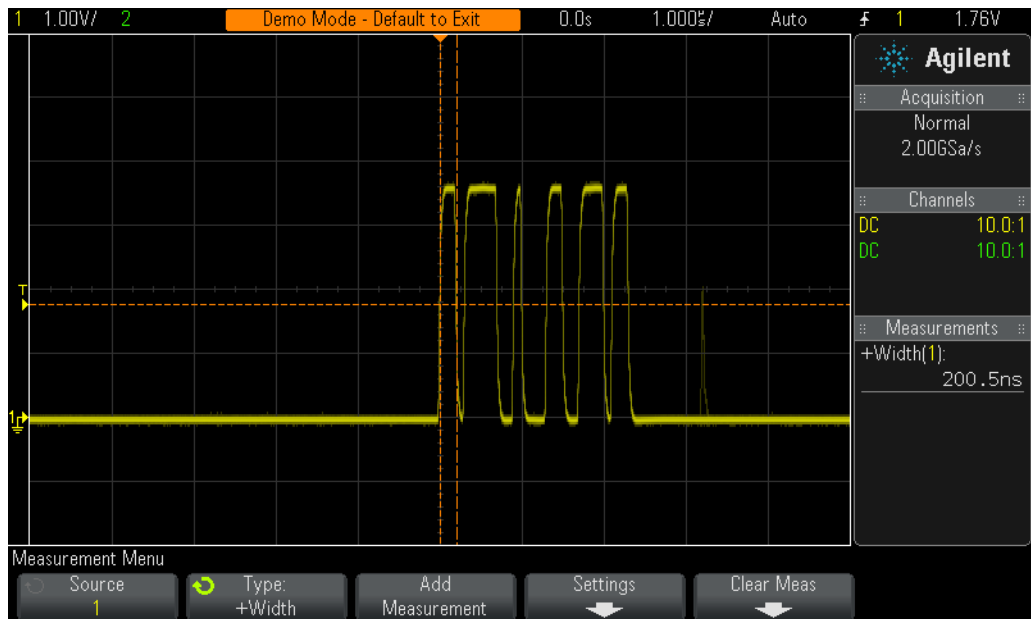

Figure 10 Using the scope's Zoom timebase mode to perform "gated" measurements.

You should now see on your scope's display an expansion of just the 3rd pulse in this burst in the lower portion of the display as should in [Figure 10](#). And the + Width measurement should be measuring the positive pulse width of just the 3rd pulse.

Lab #3: Using Waveform Math

In addition to performing automatic parametric measurements on waveform data, the oscilloscope can also perform math operations on an entire waveform or pair of waveforms. One very common waveform math function that you may want the scope to perform is to subtract one waveform from another. For instance, if you were using standard 10:1 passive probes to capture waveforms on your circuit, you would be limited to capturing these waveforms relative to ground only. But what if you wanted to see what a waveform looks like across a particular component where neither end of the component is connected to ground? In this case, you could capture waveforms at both ends of the component relative to ground, and then subtract one waveform from the other. Let's try it.

- 1 Connect the channel-1 probe to the Demo 1 terminal and ground.
- 2 Connect the channel-2 probe to the Demo 2 terminal and ground.
- 3 Press **[Default Setup]** on the scope's front panel.
- 4 Press the **[2]** front panel key to turn on Channel-2.
- 5 Press **[Help]**; then press the **Training Signals** softkey.
- 6 Select the **Phase Shifted Sine** signal using the Entry knob; then press the **Output** softkey to turn it on.
- 7 Set channel-1's V/div setting to **500 mV/div**.
- 8 Set channel-2's V/div setting to **500 mV/div**.
- 9 Set the scope's timebase to **200.0 μ s/div**.
- 10 Press the **[Math]** front panel key (right-hand side of front panel).
- 11 Press the **Operator** softkey; then turn the Entry knob to select "-".

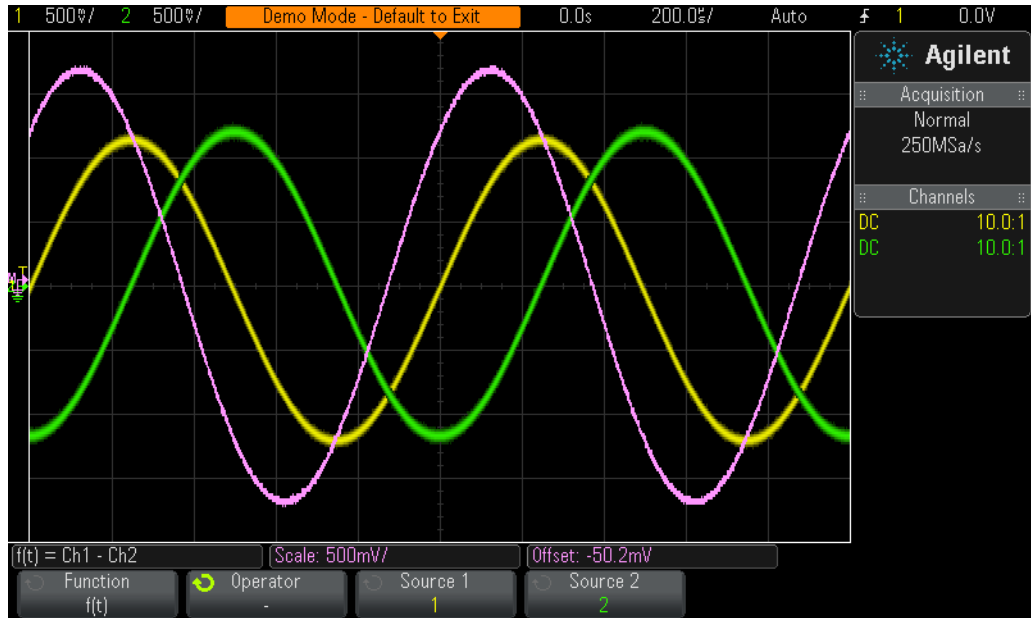

Figure 11 Using waveform math to subtract channel-2 from channel-1.

You should now see three waveforms on your scope's display as shown in [Figure 11](#). The purple waveform is the result of the scope's math function of subtracting the channel-2 waveform from the channel-1 waveform.

Note that to change the scaling of the math waveform, you can use the knobs on the right-hand side of the scope's front panel near the **[Math]** key.

Let's now vary the phase shift of the two sine waves and observe the results.

12 Press the **[Help]** front panel key; then press the **Training Signals** softkey.

13 Press the **Phase** softkey; then turn the Entry knob to vary the phase shift.

When the phase shift is exactly 180 degrees, the resultant math waveform will be at its highest amplitude as expected. When the phase shift is exactly 0 or 360 degrees, the resultant math waveform flat-lines (0.0 V). Let's now perform a more complex math function; FFT (Fast Fourier Transform).

14 Press **[Default Setup]**.

15 Press **[Help]**; then press the **Training Signals** softkey.

16 Select the **Clock with Infrequent Glitch** signal using the Entry knob; then press the **Output** softkey to turn it on.

17 Set channel-1's V/div setting to **500 mV/div**.

- 18 Set channel-1's offset to approximately **1.00 V** in order to center the waveform on-screen.
- 19 Push the trigger level knob to set the trigger level at approximately **50%**.
- 20 Set the timebase to **500.0 μ s/div**. At this timebase setting there will be many cycles of the clock signal on-screen, which is typically required when performing a precision FFT math function.
- 21 Press the **[Math]** front panel key; then press the **Operator** softkey.
- 22 Select the **FFT** math function using the Entry knob.

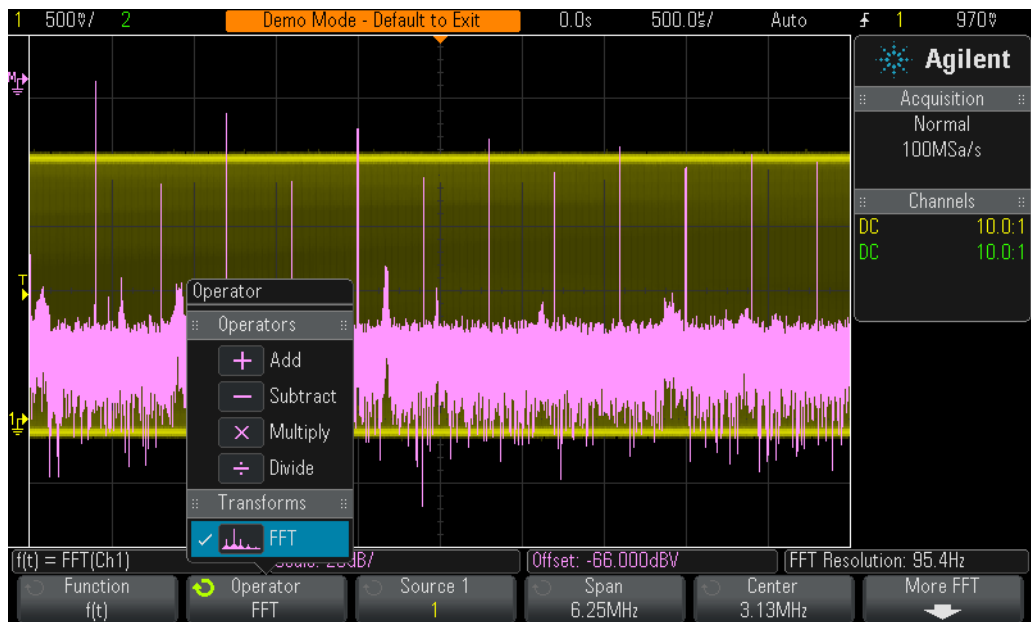

Figure 12 Performing an FFT math function on a repetitive digital clock.

You should now see a display similar to [Figure 12](#). The scope is now displaying both a time domain waveform (Voltage versus Time) as well as a frequency domain waveform (Power in units of dB versus Frequency). An FFT math function breaks signals down into their individual sine wave frequency components. All electrical signals, including digital signals, are composed of multiple sine waves of different frequencies. An ideal clock signal that has a 50% duty cycle should consist of a fundamental sine wave frequency component (signal's repetitive frequency), plus its odd harmonics (3rd, 5th, 7th, etc.). Note that non-ideal square waves will also include lower-level even harmonics. Let's now verify the frequencies of the fundamental and odd harmonics.

- 23 Press the **[Cursors]** front panel key (near the Cursors knob).
- 24 Press the **Source** softkey; then turn the Entry knob to change the **Source** from channel-1 to **Math: f(t)**
- 25 Push the Cursors knob and select the **X1** cursor.

- 26 After the Cursors menu closes, turn the Entry knob until the X1 cursor is on top of the highest frequency peak (near the left side of the display).
- 27 Push the Cursors knob again and select the **X2** cursor.
- 28 After the Cursors menu closes, turn the Entry knob until the X2 cursor is on top of the 2nd highest frequency peak.

The frequencies at the X1 and X2 cursor locations are displayed near the bottom of the scope's display.

Let's now verify the fundamental frequency of this signal using the scope's "counter" measurement.

- 29 Press the [**Meas**] front panel key.
- 30 Press the **Type** softkey; then turn the Entry knob until the arrow points to **Counter**.
- 31 Now either push the Entry knob to select this measurement, or press the **Add Measurement** softkey.

The "counter" measurement measures the average frequency over a fixed gate time to provide a very high resolution (5 digits) measure of frequency, similar to a standalone counter. But the measurement requires that the input signal be repetitive.

The "frequency" measurement measures the period of just one cycle of the signal, and then computes the frequency by taking the reciprocal.

Lab #4: Using Peak Detect Acquisition Mode

All DSOs and MSOs have a fixed amount of acquisition memory. This is the number of samples that the oscilloscope can digitize for each acquisition cycle. If the scope's timebase is set to a relatively fast time/div setting, such as 20 ns/div, then the scope will always have a sufficient amount of memory to capture a waveform at that setting using the scope's maximum specified sample rate. For example, if a scope's maximum specified sample rate is 4 GSa/s (250 ps between samples), and if the scope's timebase is set to 20 ns/div, then an acquisition memory depth of 800 points is all that is required to capture and display a complete waveform. At 20 ns/div, a complete waveform across the scope's screen would consist of 200 ns of time (20 ns/div x 10 horizontal divisions). The required memory depth to fill this time while still sampling at 4 GSa/s is then just 800 points (200ns/250ps = 800).

If you set the scope's timebase to a much slower time/div setting in order to capture slower waveforms and longer time, then the scope may need to automatically reduce its sampling rate in order to fill the required waveform time. All DSOs and MSOs do this. For example, let's assume that you want to capture a relatively slow signal and need to set the scope's timebase to 10 ms/div (100 ms across screen). If the scope's maximum memory depth is 2 M points, then the scope will need to reduce its sample rate to 20 MSa/s (100 ms/2 M = 50 ns sample period).

Although in most cases this is not a problem, because capturing slower waveforms doesn't require fast sample rates, what if the input signal consisted of a combination of low-speed and high-speed characteristics? For example, what if the input signal that you want to capture is a 30 Hz sine wave with very narrow glitches riding on it? Capturing the 30 Hz sine wave doesn't require a fast sample rate, but capturing the narrow glitches may require a very fast sample rate. Let's set up a test to capture a signal such as this.

- 1 Connect the channel-1 probe to the Demo 1 terminal and ground.
- 2 Press **[Default Setup]** on the scope's front panel.
- 3 Press **[Help]**; then press the **Training Signals** softkey.
- 4 Using the Entry knob, select the **Sine with Glitch** signal; then press the **Output** softkey to turn it on.
- 5 Set channel-1's V/div setting to **500.0 mV/div**.
- 6 Set the scope's timebase to **50.00 ms/div**.
- 7 Press the **[Intensity]** button (under the Entry knob); then set the waveform trace intensity to **100%** using the Entry knob.

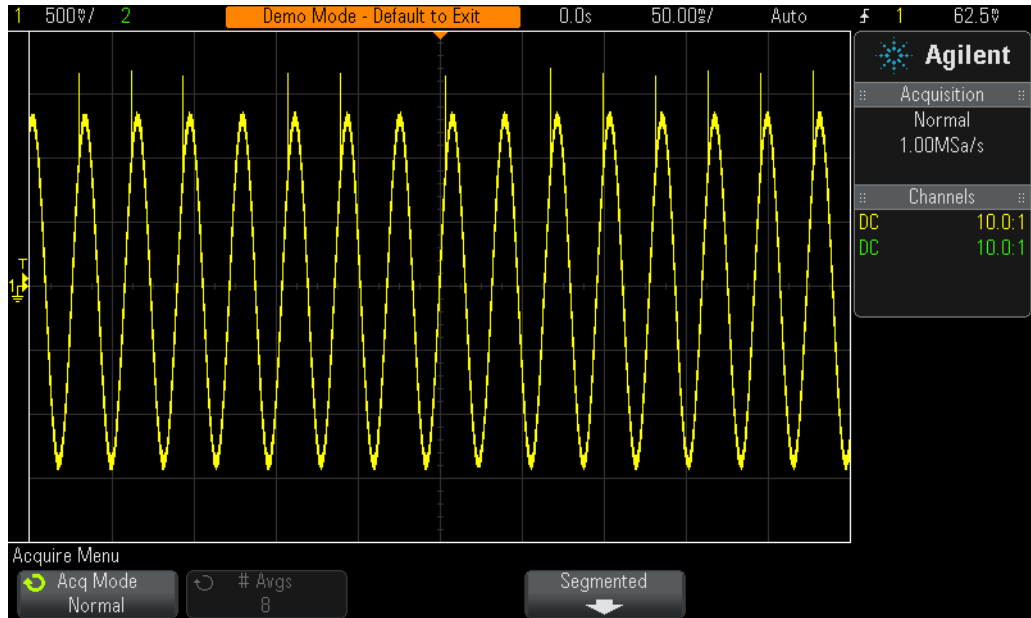

Figure 13 The scope’s automatically-reduced sample rate under-samples the repetitive glitch.

At this point, you should see a sine wave similar to [Figure 13](#). But if you look closely you should also see some glitches (narrow pulses) near the peaks of this sine wave. And the amplitude of these glitches may appear to vary (bouncing up and down). The amplitude of these glitches is actually very stable. The problem is that the scope has reduced its sample rate (note the sample rate shown under the Agilent logo on the scope’s display) and the scope is now intermittently capturing the narrow glitches. The scope is under-sampling the narrow glitches. Sometimes the scope captures a single point on the peak of a glitch. Sometimes it captures a point on a transition of the glitch. And sometimes it captures nothing at all on the glitch (the glitch width is narrower than the sample interval). This scope has a special acquisition mode called “Peak Detect” that will resolve this problem. Let’s turn it on.

- 8 Press the **[Acquire]** front panel key (below the Cursors knob).
- 9 Press the **Acq Mode** softkey; then turn the Entry knob to select **Peak Detect**.

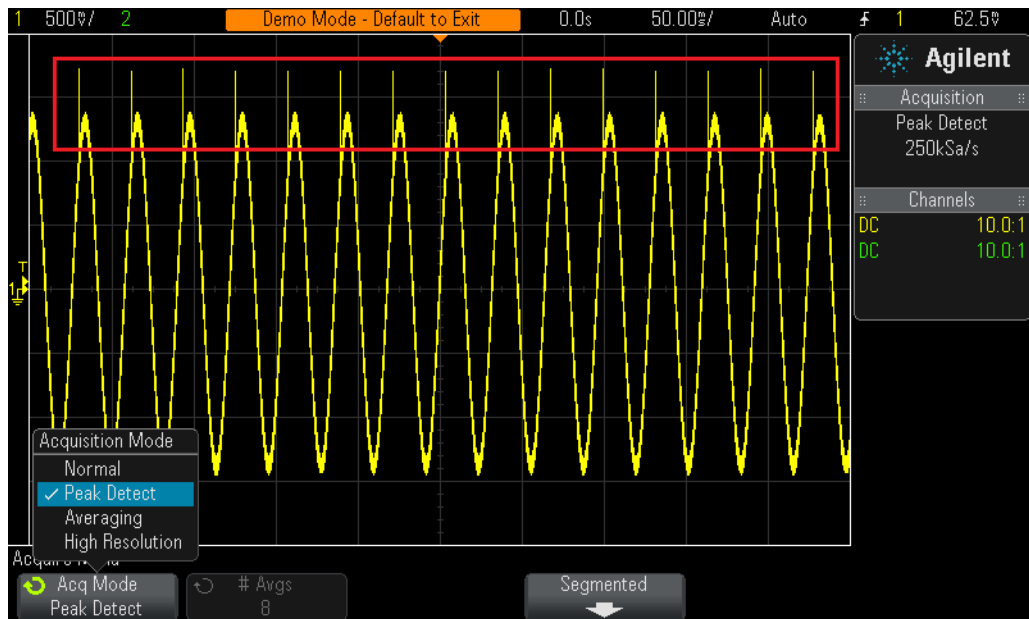

Figure 14 The Peak Detect acquisition mode reliably captures the narrow glitches riding on the slow sine wave.

The height of the glitches should now appear much more stable as shown in [Figure 14](#). When the **Peak Detect** acquisition mode has been selected, rather than sampling waveforms at a reduced rate, the scope intelligently decimates acquired data at a higher sample rate. For example, let's assume that the scope needs to run at a sample rate that is 1/100th of its maximum sample rate. This would be equivalent to running the scope at its maximum sample rate, but only storing every 1/100th point, which is "unintelligent" decimation. In the Peak Detect mode, the scope would analyze a group of 200 consecutive samples in real-time (sampled at a high rate), and then store just the maximum and minimum digitized values for this group of 200 points, which is just 2 points. This would be a decimation factor of 100.

So you may ask why not always use the **Peak Detect** mode? There are some tradeoffs when using this mode of acquisition. First of all, the scope's absolute maximum sample rate is reduced. Secondly, stored points will NOT be evenly spaced. And this is an important criterion of the Nyquist Sampling theorem. So for this particular measurement application, using the **Peak Detect** mode is a good choice. But for other measurement applications, **Peak Detect** may not be the appropriate acquisition mode.

To learn more about oscilloscope real-time sampling, refer to Agilent's Application Note titled, "*Evaluating Oscilloscope Sample Rates vs Sampling Fidelity*" listed in "[Related Agilent Literature](#)" on page 101.

Lab #5: Using Segmented Memory Acquisition Mode

All oscilloscopes have a limited amount of acquisition memory. The amount of acquisition memory that your scope has will determine the length of time it can capture while still using a fast sampling rate. You can always capture a long time span by simply setting the timebase to a long time/div setting. But the scope may automatically reduce its sample rate in order to capture the long time-span which will reduce acquired waveform detail and measurement resolution. Using this scope's Segmented Memory acquisition mode is another solution to optimize memory depth and sample rate; especially when attempting to capture multiple low duty cycle type signals. To enable Segmented Memory Acquisition, your oscilloscope must have the Segmented Memory option installed (Option SGM). You can verify the installed options on your oscilloscope at **[Help] > About Oscilloscope**. Let's now attempt to capture and display a simulated low duty cycle radar burst.

- 1 Connect the channel-1 probe to the Demo 1 terminal and ground.
- 2 Press **[Default Setup]** on the scope's front panel.
- 3 Press **[Help]**; then press the **Training Signals** softkey.
- 4 Using the Entry knob, select the **RF Burst** signal; then press the **Output** softkey to turn it on.
- 5 Set channel-1's V/div setting to **500.0 mV/div**.
- 6 Set the scope's timebase to **200.00 ns/div**.
- 7 Set the scope's trigger level to approximately **+700 mV** (~1.5 divisions above center-screen).
- 8 Press the **[Intensity]** button (under the Entry knob); then set the waveform trace intensity to **100%** using the Entry knob.

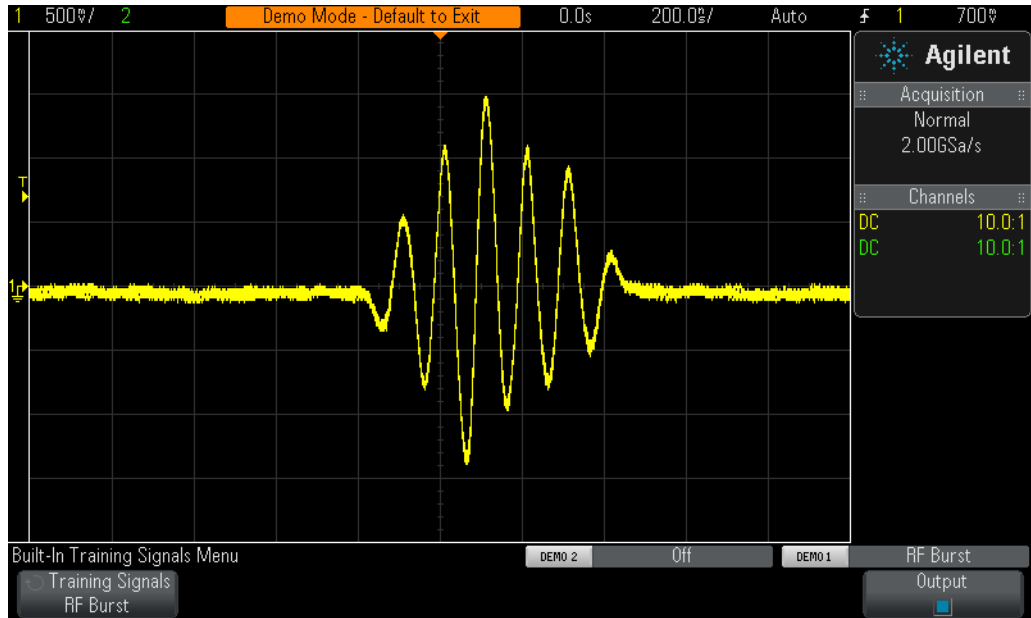

Figure 15 Capturing and displaying an RF burst at 200.0 ns/div.

You should see a single burst of sine waves similar to what is shown in [Figure 15](#). Let's now rescale the timebase in an attempt to capture several of these bursts.

9 Set the scope's timebase to **2.000 ms/div**.

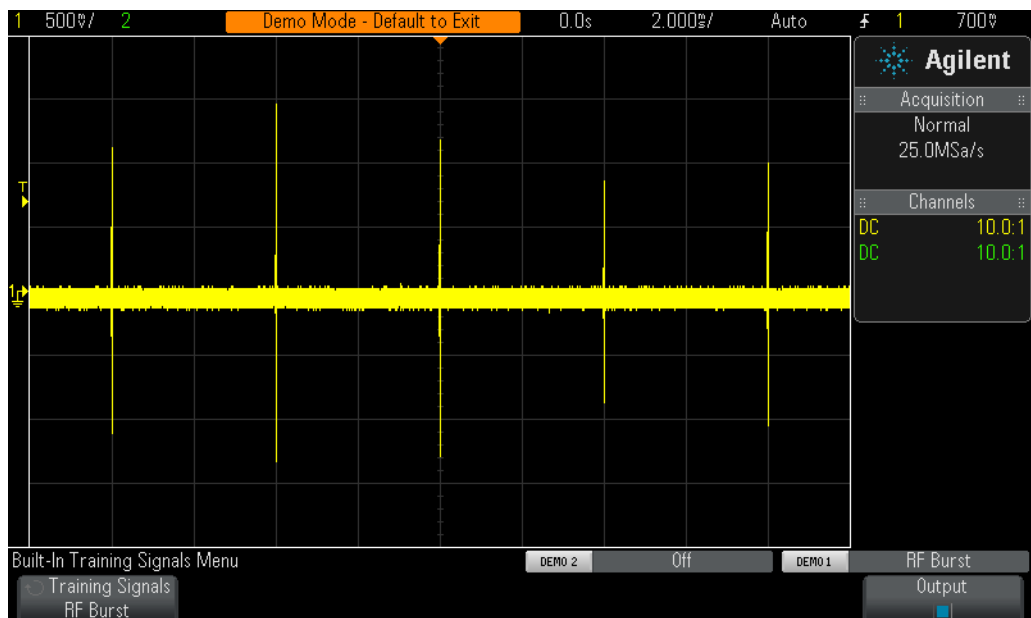

Figure 16 Capturing multiple RF burst waveforms at a slower timebase setting.

When we attempt to capture multiple RF bursts that are separated by 4.0 ms, the scope under-samples and shows varying amplitudes of the signal as shown in [Figure 16](#). Again, this is because the scope automatically reduced its sample rate in order to capture a longer time-span with its limited amount of acquisition memory. Let's now zoom-in and take a closer look at this under-sampled data.

10 Press **[Run/Stop]** to stop repetitive acquisitions (**[Run/Stop]** key will turn red).

11 Now set the scope's timebase to **200.0 ns/div**.

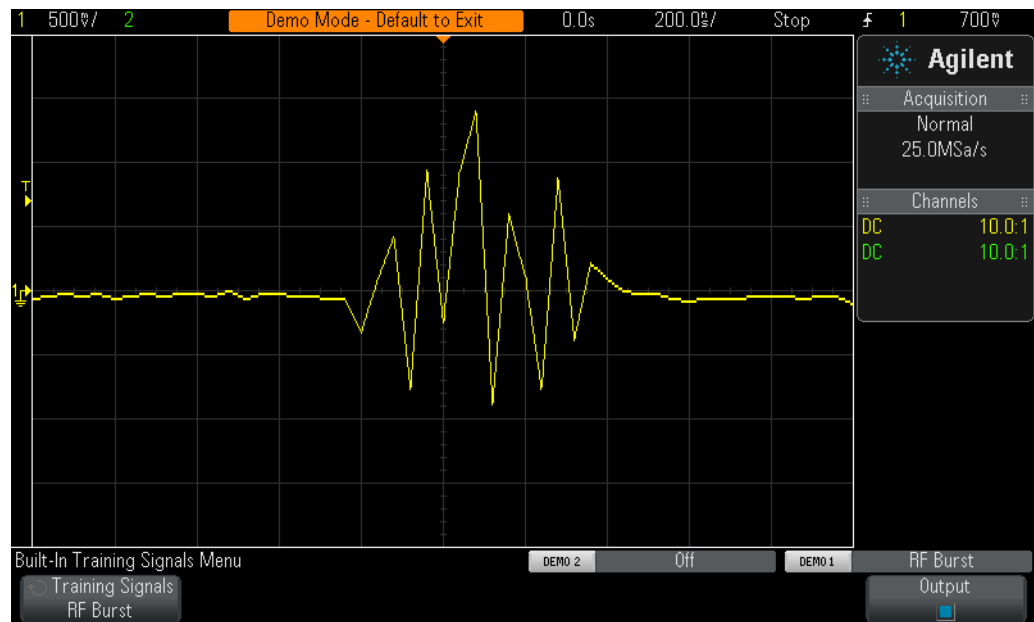

Figure 17 Zooming in reveals an under-sampled waveform.

After acquiring the waveform at the slower timebase setting, and then zooming in, we can clearly see that our waveform was under-sampled as evidenced by the triangular shaped waveforms shown in [Figure 17](#). Remember, this should be a burst of sine waves.

Although using the scope's Peak Detect mode would provide us with a more accurate measure of the peak amplitudes of each burst when captured at the slower timebase setting ([Figure 16](#)), we would see that the waveform would still be under-sampled after zooming in on a stored trace. Another solution would be to purchase a scope with much deeper memory. Let's now use the scope's Segmented Memory acquisition mode to capture multiple bursts with high resolution.

12 Press **[Run/Stop]** to begin repetitive acquisitions again with the timebase still set at 200.0 ns/div (**[Run/Stop]** should turn green).

13 Press the **[Acquire]** front panel key (near the Cursors knob); then press the **Segmented** softkey (only available if licensed with the SGM option).

14 Turn the Entry knob until **# of Segs = 25**.

15 Now press the **Segmented** softkey to turn on this mode of acquisition.

The scope should have just captured 25 consecutive occurrences of this burst. Let's review them.

16 Press the **Current Seg** softkey; then turn the Entry knob to review all 25 waveforms.

17 Now set the **Current Seg = 25** using the Entry knob (last captured segment/waveform).

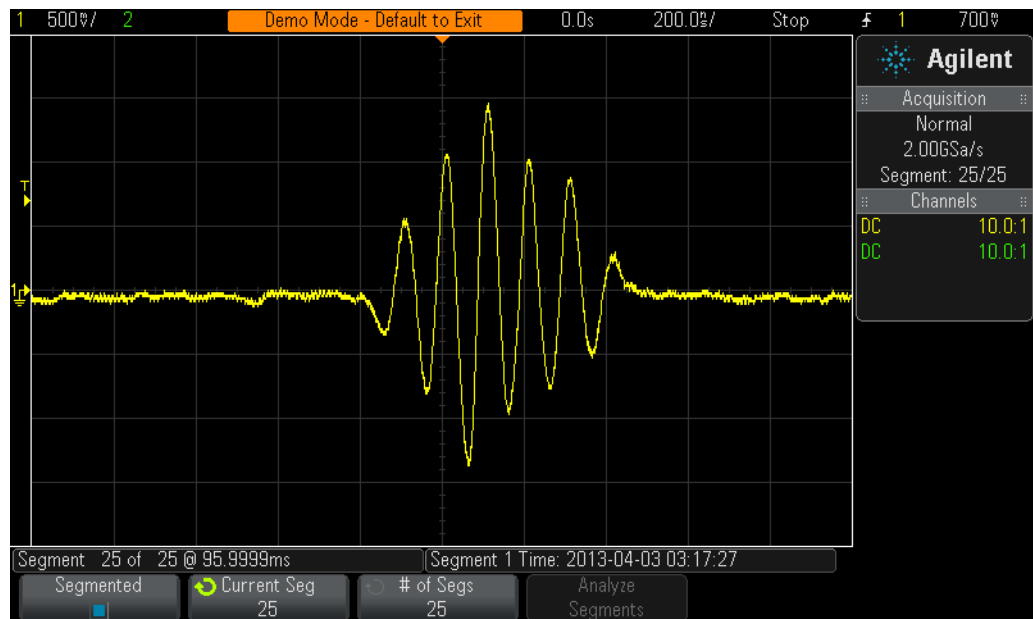

Figure 18 Using Segmented Memory Acquisition to capture more waveforms with high resolution.

Along with capturing consecutive low duty cycle signal bursts, the scope also “time-tags” each segment/waveform so that you know the time of each capture segment/waveform relative to the first captured segment/waveform. Time-tags are shown in the lower left-hand corner of the display. Segment #25 should have a time-tag of approximately 100 ms along with a time-of-day stamp as shown in Figure 18. The captured waveform should also have very high resolution because the scope used a high sample rate to capture each waveform. If you attempted to capture ~100 ms (10 ms/div) of time-span using the scope’s Normal acquisition mode, the scope would have significantly reduced its sample rate and thereby would have provided extremely poor sample resolution on each burst.

2 Oscilloscope Familiarization Labs

Segmented Memory acquisition optimizes oscilloscope acquisition memory by only capturing waveform data around small portions (or segments) of a signal (a short sine wave burst in this case). The scope does not capture unimportant signal idle-time between each burst. Segmented Memory acquisition can also be a very useful tool for capturing multiple serial packets of digital data, which will be demonstrated in [Chapter 4](#), “Serial Bus Decoding & Triggering, Search & Navigation, and Segmented Acquisition Labs,” starting on page 53.

Lab #6: Using Mask Test

With mask testing you can set up a pass/fail test criteria for automatically testing waveforms to see if they conform to specific wave shapes. In this lab we will test a digital signal that includes an infrequent glitch. With InfiniiVision's hardware-based mask testing capability, we will be able to test up to 50,000 waveforms per second and gain insight into the statistical occurrences of this particular glitch. To enable Mask Testing, your oscilloscope must have the mask test option installed (Option MASK). You can verify the installed options on your oscilloscope at **[Help] > About Oscilloscope**.

- 1 Connect the channel-1 probe to the Demo 1 terminal and ground.
- 2 Press **[Default Setup]** on the scope's front panel.
- 3 Press **[Help]**; then press the **Training Signals** softkey.
- 4 Using the Entry knob, select the **Clock with Infrequent Glitch** signal; then press the **Output** softkey to turn it on.
- 5 Set channel-1 to **500 mV/div** and position/offset to **1.0 V**.
- 6 Push the Trigger Level knob to set the trigger level at **50%**.
- 7 Set the timebase to **20 ns/div**.
- 8 Set the waveform intensity to **100%** by first pressing the **[Intensity]** button; then turn the Entry knob.

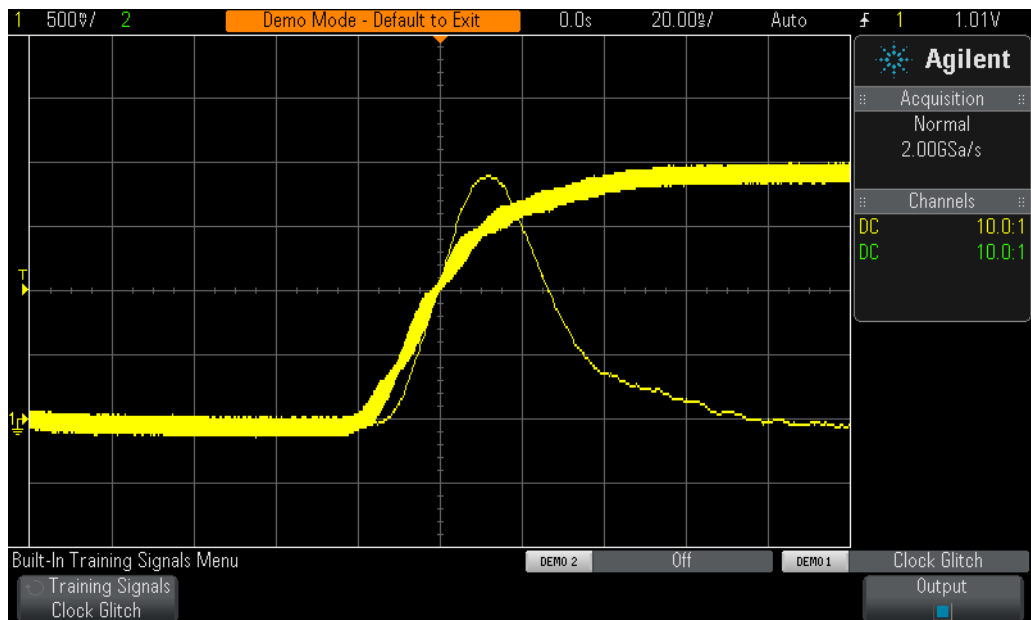

Figure 19 The scope's fast waveform update rate easily captures an infrequent glitch.

At this point, you should be able to see that the scope is capturing an infrequent glitch as shown in [Figure 19](#). This particular glitch occurs just once every 30,000 cycles of the clock signal that we are triggering on. Because this scope can update waveforms as fast as 50,000 waveforms/sec, the scope can capture the glitch on average once or twice per second. Let's now use the scope's Mask Test capability to analyze this glitch.

- 9 Press **[Analyze]**.
- 10 Press **Features Mask** two times to turn on mask testing.
- 11 Press **Automask**.
- 12 Press **Create Mask** to automatically create a pass/fail mask around this waveform.

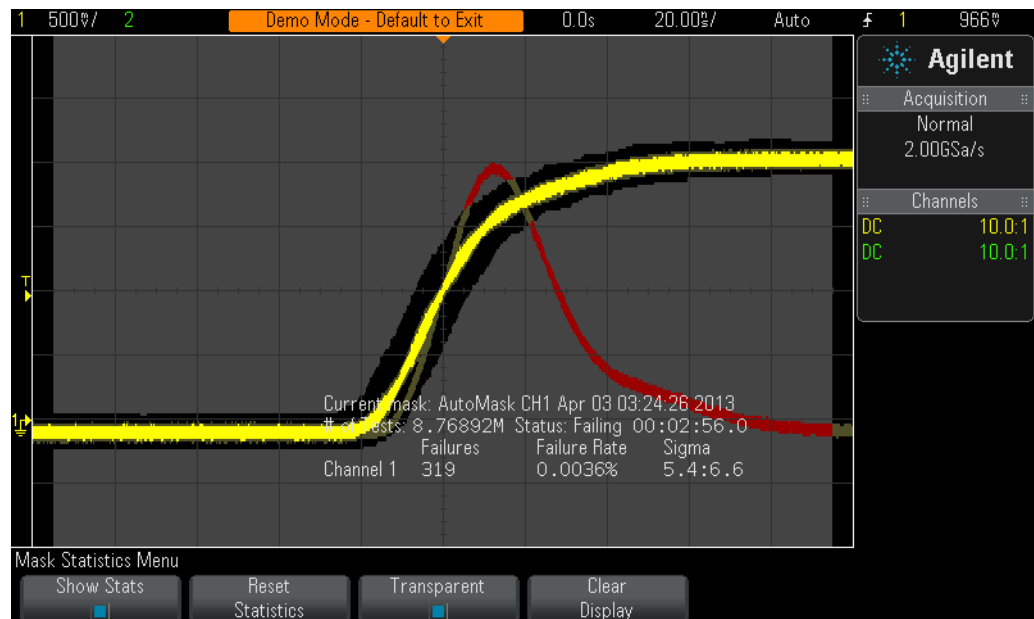



Figure 20 Mask Testing provides us within detailed statistics about the rate of occurrence of the infrequent glitch.

Because the InfiniiVision oscilloscope's mask testing capability is hardware-based, it can test up to 50,000 waveforms/sec and provide detailed pass/fail statistics including failure rate in terms of both percent and a Sigma quality factor as shown in [Figure 20](#). A Sigma quality factor of 6σ relates to approximately three or fewer defects per million tested. Because this particular glitch occurs 1/30,000, we have a Sigma quality factor that is lower than 6σ . Let's now set up the oscilloscope to stop on the first detected failure.

- 13 Press **[Run/Stop]** to stop acquisitions.
- 14 Press the  (Back) key.
- 15 Press **Statistics**.

- 16 Press **Reset Statistics** to clear the statistics from the previous test.
- 17 Press the  (Back) key.
- 18 Press **Setup**.
- 19 Press **On Error – Stop** two times.
- 20 Press **[Run/Stop]** to begin a new “Stop-on-Error” test.



Figure 21 Establishing specific test criteria.

In addition to stopping acquisitions when an error is detected as shown in [Figure 21](#), you can also save a waveform, save an image, print, or perform specific measurements when an error is detected. Using the “Run Until” selection, you can also set up mask testing to run for a specific number of tests, minimum time, or minimum Sigma test criteria. Note that in addition to creating a pass/fail mask using the auto-mask creation feature as demonstrated in this lab, you can also import a mask based on industry specifications, such as an eye-diagram mask, from a USB memory device. These types of imported masks can be easily created within a standard text editor, such as NotePad on your PC.

2 Oscilloscope Familiarization Labs

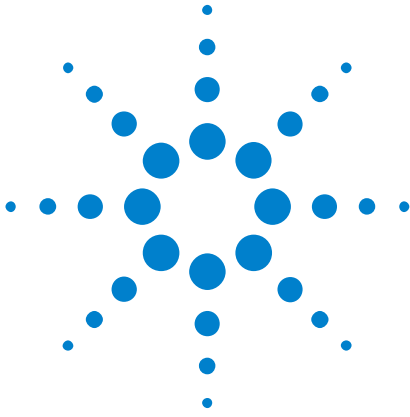

3 Advanced Triggering, Search & Navigation, and Segmented Acquisition Labs

Lab #7: Triggering on a Digital Burst using Trigger Holdoff 40

Lab #8: Triggering on Unique Pulses and Glitches using “Pulse-width”
Trigger 44

Lab #9: Triggering on Logic Patterns using the MSO’s Digital
Channels 48



Lab #7: Triggering on a Digital Burst using Trigger Holdoff

Signals in the real world of electronics are rarely as simple as repetitive sine waves and square waves. Establishing unique trigger points on more complex signals sometimes requires using trigger “hold-off”. In this lab you will learn how to use the scope’s trigger hold-off capability in order to trigger on a burst of digital pulses.

- 1 Connect the channel-1 probe to the Demo 1 terminal and ground.
- 2 Press **[Default Setup]** on the scope’s front panel.
- 3 Press **[Help]**; then press the **Training Signals** softkey.
- 4 Using the Entry knob, select the **Digital Burst** signal; then press the **Output** softkey to turn it on.
- 5 Set channel-1’s V/div setting to **1.00 V/div**.
- 6 Set channel-1’s offset/position to approximately **+1.7 V** in order to center this waveform on the scope’s display.
- 7 Push the Trigger Level knob to automatically set the trigger level to approximately **50%**.
- 8 Set the scope’s timebase to **20.00 μ s/div**.

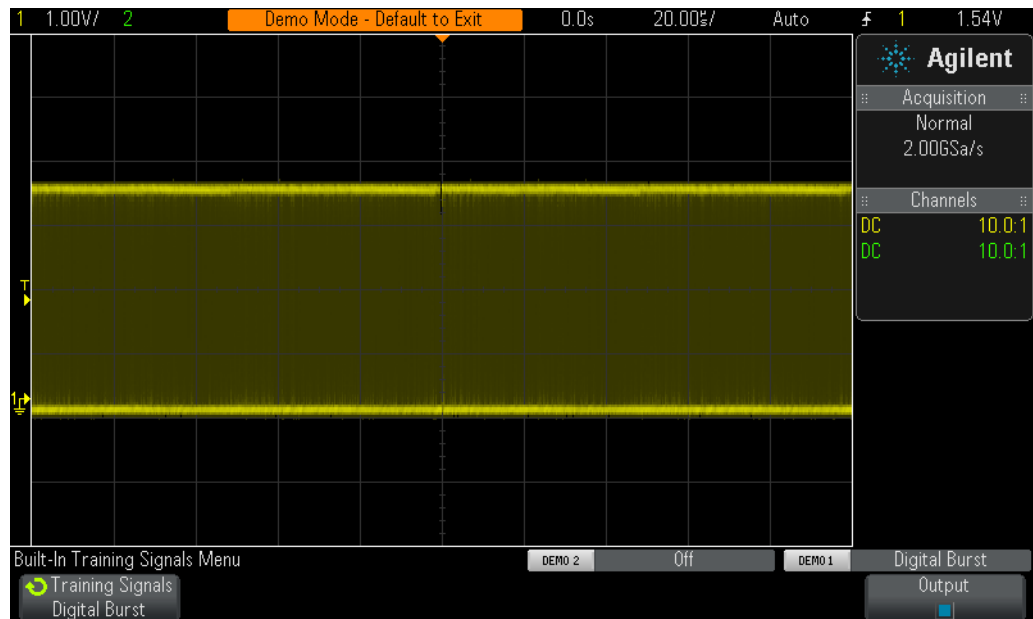

Figure 22 Attempting to view a burst of pulses while using the scope’s default trigger setup conditions.

You should see on your scope's display what may appear to be an un-triggered display of a series of digital pulses similar to [Figure 22](#). The scope is actually triggering on random rising edge crossings of this complex digital data stream, which is actually a “burst” of pulses. Unfortunately we can't “see” the burst activity because we haven't yet set up the scope to establish a unique trigger point on this complex signal. So let's now “stop” repetitive acquisitions so that we can see a single-shot acquisition of the bursts, and then make some measurements. We will then use these measurements to enter a specific trigger holdoff time in order to synchronize triggering on the 1st pulse of each burst.

9 Press the **[Run/Stop]** front panel key to stop repetitive acquisitions.

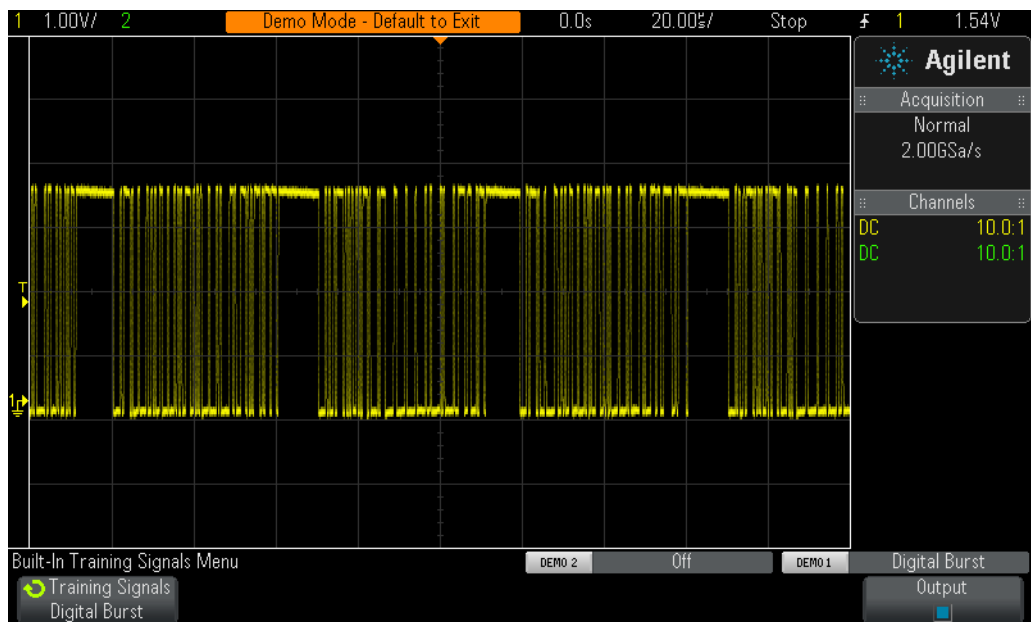

Figure 23 Single-shot acquisition reveals digital burst activity.

With repetitive acquisitions stopped, you should now be able to see digital burst activity as shown in [Figure 23](#). In other words, there are a series of negative pulses followed by a short idle-time (high level), and then it repeats. If you press **[Single]** several times, you should observe that the trigger event (rising edge closest to center-screen) for each acquisition is almost always a different pulse within the burst.

Estimate or use the scope's timing cursors (X1 & X2) to measure the width of one of the burst of pulses, and also measure the time from the beginning of one burst of pulses to the beginning of the next burst of pulses. You should find that the width of each burst is approximately 40 μ s, and the time between bursts is approximately 50 μ s.

When we use the scope's default triggering condition, the scope triggers on "any" random edge of this signal. In other words, sometimes the scope triggers on the 1st edge of the burst, sometimes the 11th edge of the burst, sometimes the 5th edge, etc. An ideal synchronization point would be to set up the scope so that it always triggers on just the 1st edge of each burst, rather than a random edge. We can do this using the scope's "trigger holdoff" capability.

With trigger holdoff, we can instruct the scope to always arm triggering during the signal idle-time between each burst of pulses. This way the scope will always trigger on the next rising edge after arming, which will always be the 1st edge in each burst. An ideal holdoff time to achieve this would be a trigger holdoff time somewhere between 40 μs (width of burst) and 50 μs (time between bursts). This may sound confusing, so let's just do it and see what happens.

- 10 Press the **[Run/Stop]** front panel key to begin repetitive acquisitions again.
- 11 Press the **[Mode/Coupling]** key in the Trigger section of the front panel.
- 12 Press the **Holdoff** softkey; then turn the Entry knob clockwise until the holdoff value is set to approximately **45.000 μs** .

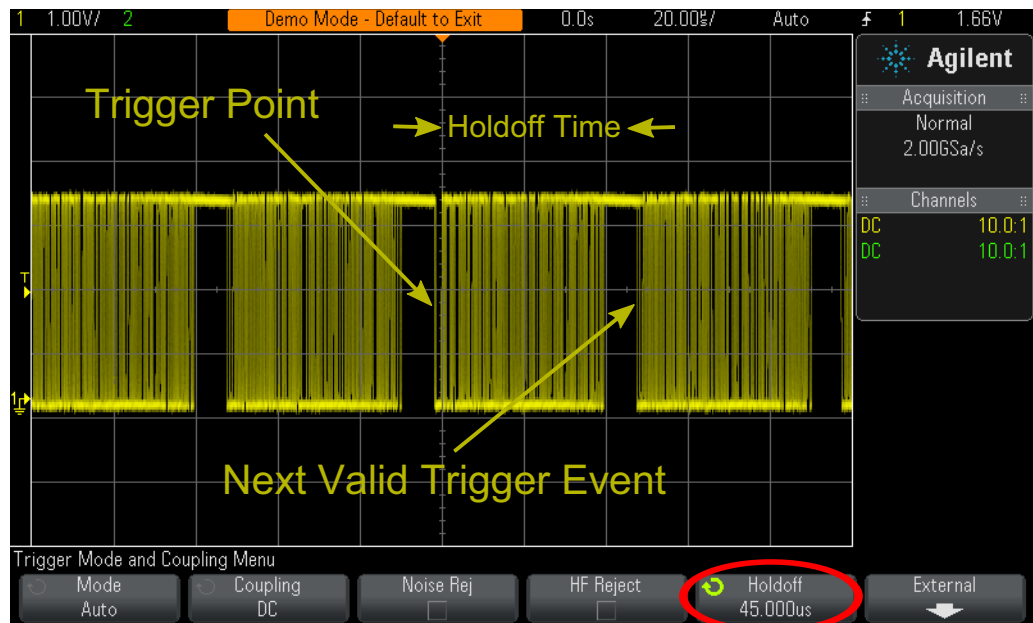

Figure 24 Using the scope's trigger holdoff feature to synchronize on a burst of pulses.

You should now see a synchronized display as shown in [Figure 24](#). The scope triggers on the 1st edge of a burst of pulses (center-screen) and then disables triggering for 45.00 μs (holdoff time). During this holdoff time, the scope ignores the 2nd, 3rd, 4th, etc., crossings, and then re-arms

triggering after the end of the burst, but before the beginning of the next burst, which is during the signal's "idle-time". The next valid trigger event will again be the 1st edge crossing on the next burst.

Lab #8: Triggering on Unique Pulses and Glitches using “Pulse-width” Trigger

In this lab you will learn how to use the scope’s Pulse Width triggering mode to trigger on pulses within a digital data stream that have unique pulse widths, including an infrequently occurring glitch.

- 1 Connect the channel-1 probe to the Demo 1 terminal and ground.
- 2 Press **[Default Setup]** on the scope’s front panel.
- 3 Press **[Help]**; then press the **Training Signals** softkey.
- 4 Using the Entry knob, select the **Digital Burst with Infrequent Glitch** signal; then press the **Output** softkey to turn it on.
- 5 Set channel-1’s vertical scaling to **1.00 V/div**.
- 6 Set channel-1’s offset/position to approximately **+1.7 V** in center the waveform on-screen.
- 7 Set the trigger level to **+1.00 V** (~1 division above bottom of waveform).
- 8 Set the scope’s timebase to **2.000 μ s/div**.

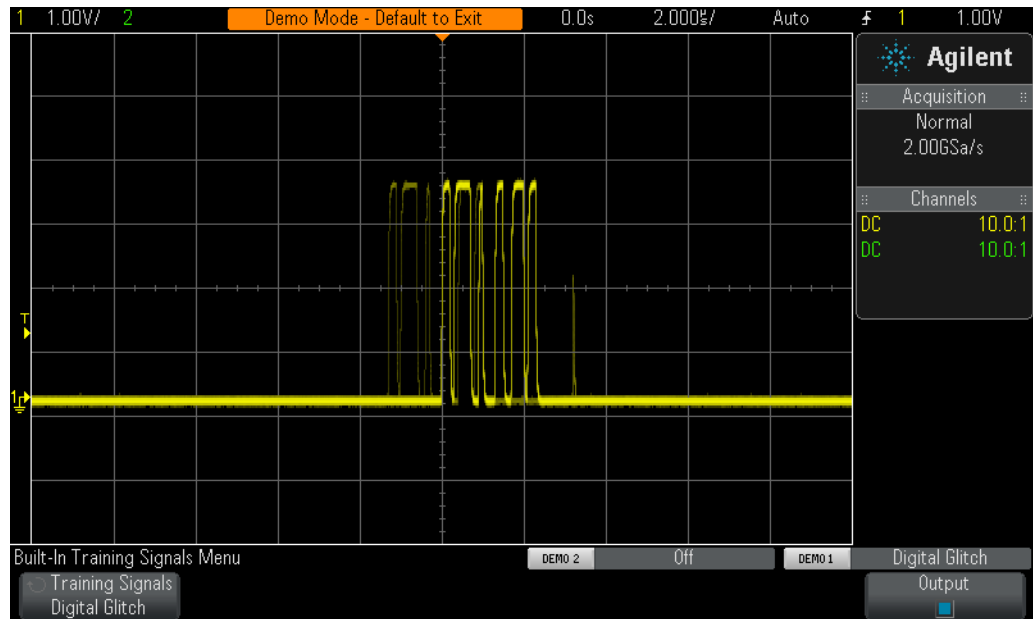

Figure 25 Capturing a digital burst using the scope’s default Edge triggering mode.

You should now see on your scope’s display a digital burst waveform consisting of six pulses of various widths, followed by an infrequent glitch similar to [Figure 25](#). Using the scope’s default Edge triggering mode, the scope usually triggers on the 1st pulse of this burst. But if you increase the scope’s waveform intensity to 100%, you will see that the scope

sometimes triggers on later pulses within this burst. We could further stabilize triggering on the 1st pulse in this burst if we used the scope's trigger holdoff capability. But what if we wanted to trigger on a specific pulse (other than the 1st pulse)? We could accomplish this by using the scope's "Pulse Width" triggering mode, which can be used on a continuous data stream of digital pulses; the data stream does not need to come in bursts. But the pulses must have a unique pulse width for this triggering mode to be effective. Note that the 5th pulse within this burst has a positive pulse width of approximately 300 ns. This is a unique pulse width within this burst of pulses. Let's now set up the scope to trigger specifically on this pulse.

- 9 Press the [**Trigger**] front panel key; then select the **Pulse Width** trigger type using the Entry knob.
- 10 Press the "< > ><" softkey; then select the "><" time qualifier.
- 11 Press the "< 30 ns" softkey; then set the time to < 350 ns using the Entry knob.
- 12 Press the "> 20 ns" softkey; then set the time to > 250 ns using the Entry knob.
- 13 Set the scope's timebase to **500.0 ns/div**.

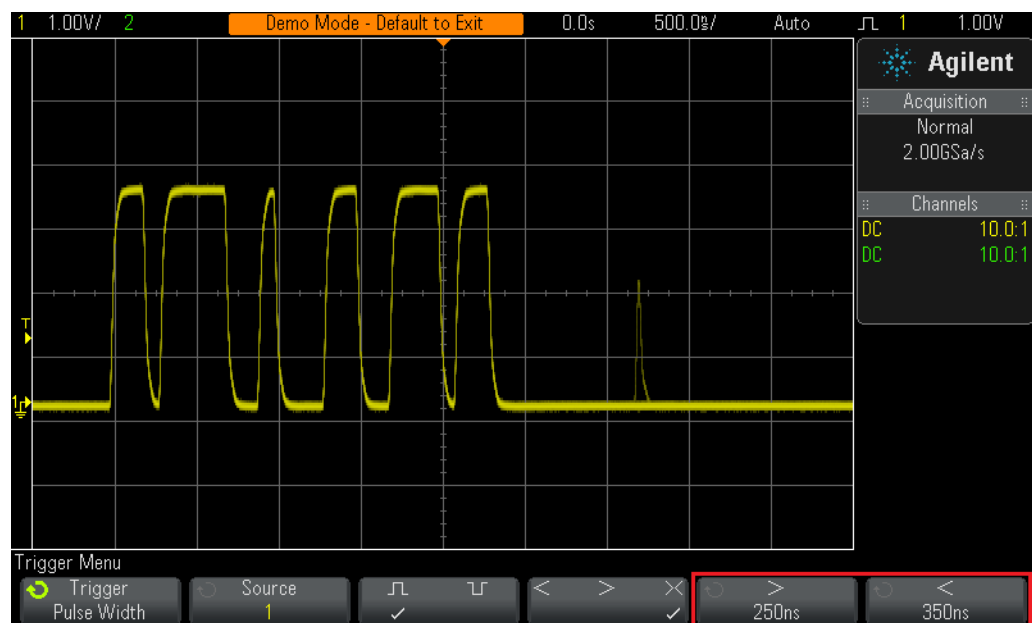

Figure 26 Triggering on a 300 ns wide pulse using the scope's Pulse Width triggering mode.

3 Advanced Triggering, Search & Navigation, and Segmented Acquisition Labs

Your scope should now be triggering at the end of the 5th pulse of the burst as shown in [Figure 26](#). This particular pulse uniquely meets the pulse width time qualification of > 250 ns, but < 350 ns. You can select the **+Width** measurement if you would like to verify that this pulse has an approximate width of 300 ns.

Now take note of the narrow infrequent glitch that occurs after the end of this burst of six pulses. In addition to using the scope's Pulse Width trigger type to trigger on "known" pulses that have unique widths, such as this 300 ns wide pulse, we can also use the Pulse Width triggering mode to trigger on "unknown" or "unwanted" glitches. Let's do it.

14 Press the " $< > ><$ " softkey; then select the " $<$ " time qualifier.

15 Press the **< 30 ns** softkey; then set the time to **< 50 ns**.



Figure 27 Triggering on a narrow infrequent glitch using the scope's Pulse Width triggering mode.

Your scope should now be triggering on the narrow infrequent glitch that follows the repetitive burst of six pulses as shown in [Figure 27](#). Note that if this glitch was more infrequent, you would also need to select the **Normal** trigger mode to avoid auto triggering.

Let's now use the scope's Segmented Memory mode of acquisition to capture 25 consecutive occurrences of this glitch to see if we can determine how often the glitch occurs relative to the occurrence of each burst. To complete the rest of this lab your scope must be licensed with the Segmented Memory option.

16 Press the **[Acquire]** front panel key.

- 17 Press the **Segmented** softkey; then turn the Entry knob to select **25** as the number of segments to capture.
- 18 Press the **Segmented** softkey to begin a Segmented Memory acquisition.
- 19 Press the **Current Segment** softkey; then turn the Entry knob to review all 25 captured segments.
- 20 Set the **Current Segment** to **2** and note the time-tag of this captured segment.

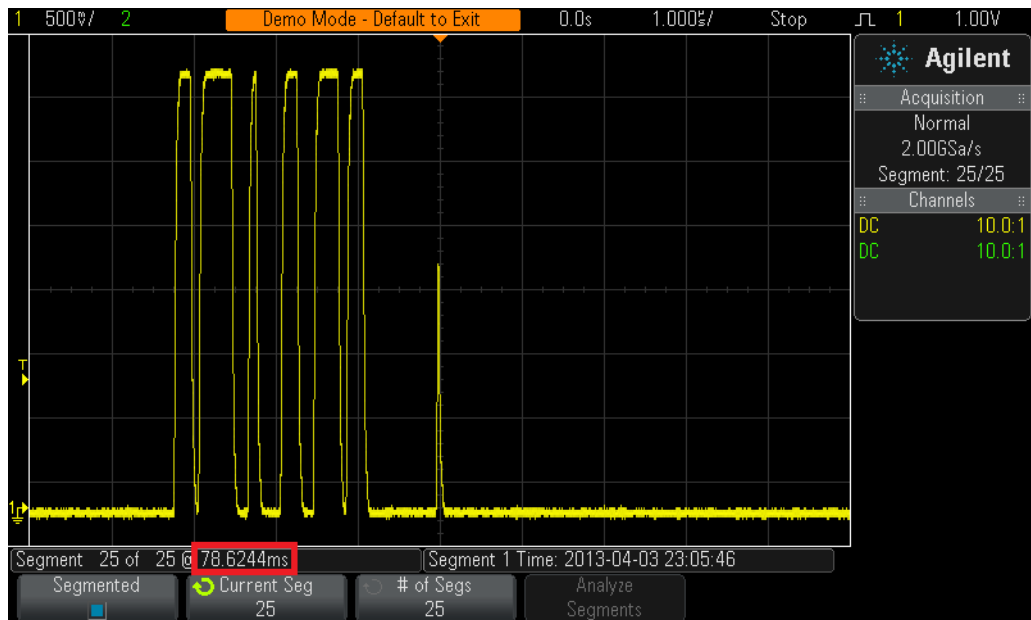

Figure 28 Using the scope's Segmented Memory acquisition to selectively capture 25 consecutive occurrences of a burst of pulses.

Segmented Memory optimizes oscilloscope acquisition memory by only capturing important segments of a waveform based on the trigger condition and timebase setting. In this example, we have selectively captured 25 consecutive occurrences of this glitch for a total acquisition time of than 78 ms as shown in [Figure 28](#). The scope did not waste valuable acquisition memory capturing signal idle time between each glitch. But the scope does provide us with timing information about the time of each segment relative to the first captured segment. As you were reviewing each captured segment, you should have determined that the glitch occurs every 3.27 milliseconds.

Lab #9: Triggering on Logic Patterns using the MSO's Digital Channels

In this lab you will learn how to use the scope's digital channels of acquisition (MSO), and then set up the scope to trigger on a specific Boolean pattern combination. Note that to complete this lab your scope must either be an MSO model, or a DSO model that has been upgraded with the MSO option (Option MSO). You can verify the installed options on your oscilloscope at [Help] > About Oscilloscope.

- 1 Connect the channel-1 probe to the Demo 1 terminal and ground.
- 2 Press [Default Setup] on the scope's front panel.
- 3 Press [Help]; then press the **Training Signals** softkey.
- 4 Using the Entry knob, select **Analog & Digital Signals**; then press the **Output** softkey to turn it on.
- 5 Set channel-1 to **500 mV/div**.
- 6 Push the trigger level knob to set the trigger level to approximately **50%**.
- 7 Set the scope's timebase to **50.00 μ s/div**.
- 8 Press the [Digital] front panel key (right side of scope) to turn on the digital channels of acquisition.

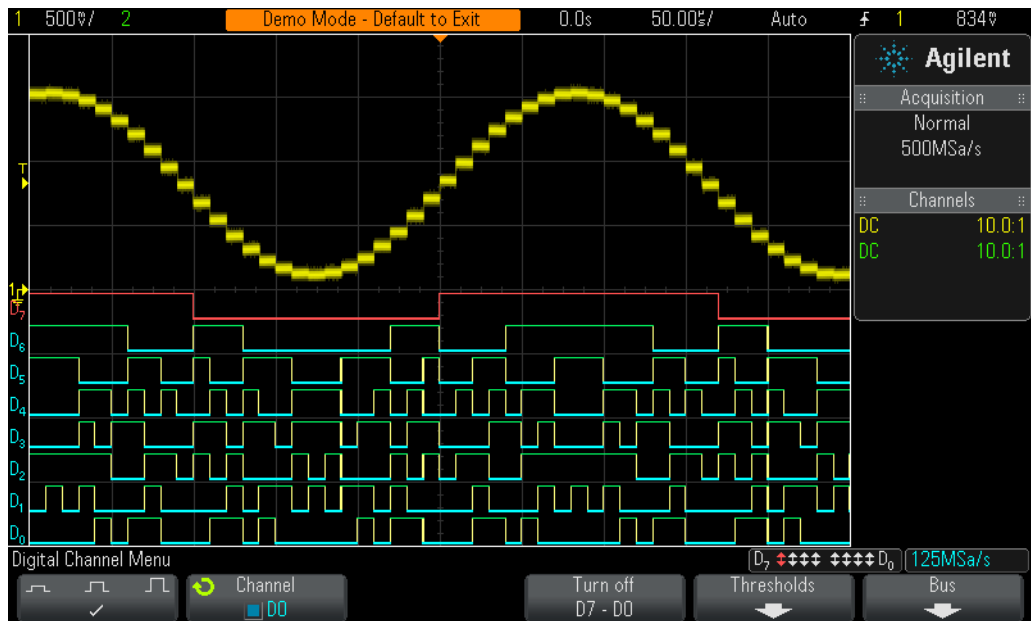

Figure 29 Capturing multiple analog and digital signals with an MSO.

You should now see on your scope's display a stair-step sine wave on channel-1 plus eight digital waveforms captured by the D0 through D7 digital channels of acquisition similar to [Figure 29](#). D0 through D7 are the

input signals to an digital-to-analog converter (DAC), while the stair-step sine wave is the output of the DAC. At this point, you may be wondering where these digital signals are coming from. Are they real or just simulated? They are real signals generated by an internal pattern generator inside the scope. They are then internally routed directly to eight digital/logic acquisition channels of the scope (D7-D0); bypassing the parallel logic probe. In a real measurement application such as this, you would use the logic probe that is supplied with the scope to probe signals such as these.

The scope is currently triggering on the output of the DAC (channel-1) using the scope's default Edge triggering mode. We can also set up the scope to trigger on Boolean pattern conditions based on the input of the DAC (D7-D0), which might be necessary if the output signal were more complex than a repetitive sine wave. Let's now set up the scope to trigger on an input pattern condition = 1110 0110 (binary D7 – D0), which is equivalent to E6 (HEX). Note that this input logic pattern condition will be coincident with the highest output level of the DAC (positive peak of the stair-step sine wave).

- 9 Press the **[Trigger]** front panel key; then select **Pattern** using the Entry knob.
- 10 Press the **Channel** softkey; then select **D7** using the Entry knob.
- 11 Press the **Pattern** softkey; then select **1** as the pattern condition for D7.
- 12 Press the **Channel** softkey two times to select **D6**.
- 13 Press the **Pattern** softkey; then select **1** as the pattern condition for D6.
- 14 Repeat the above process until:

Pattern = 1 XX 2 D₇ 1110 0110 D₀

3 Advanced Triggering, Search & Navigation, and Segmented Acquisition Labs

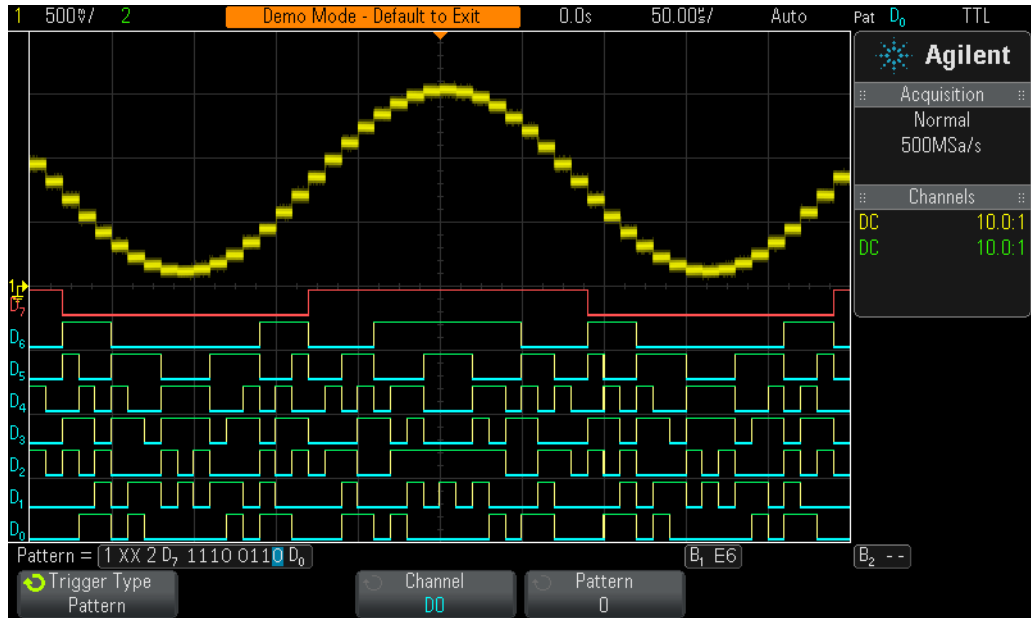

Figure 30 Triggering on Pattern = 1110 0110.

Your scope should now be triggering on logic pattern 1110 0110 (D7-D0), and the top of the sine wave should be centered on-screen as shown in [Figure 30](#). In addition to displaying individual digital channels, this scope can also display all of the digital channels of acquisition in an overlaid bus display mode while displaying the HEX value of the bus. Let's now set up the scope to show the bus display mode.

15 Press the **[Digital]** front panel key; then press the **Bus** softkey.

16 Press the **Bus** softkey two times to enable the B1 bus display mode.

17 Set the scope's timebase to **20.00 µs/div**.

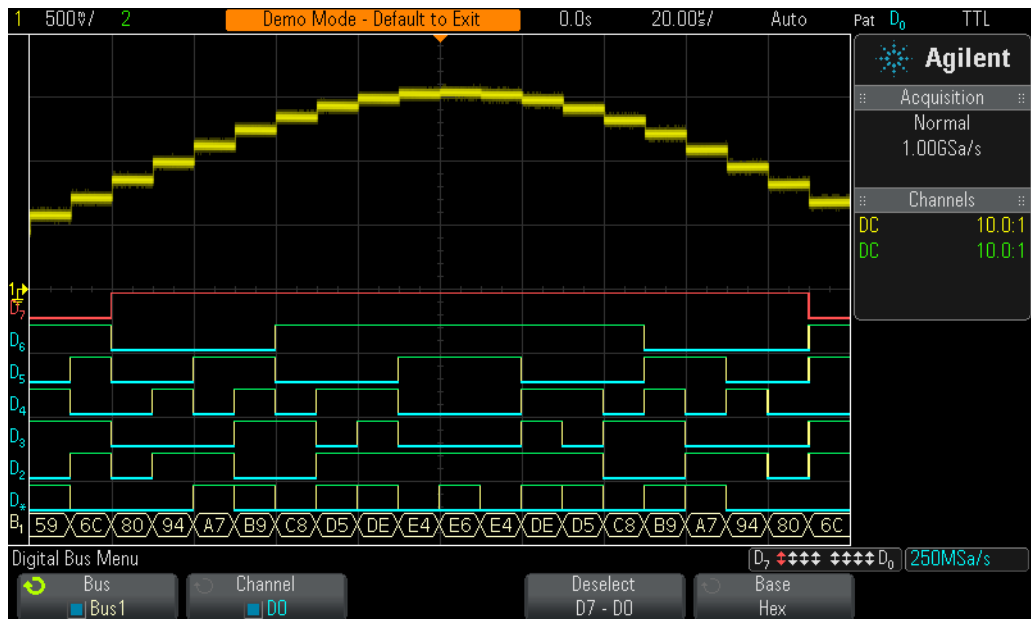

Figure 31 Displaying digital channels in a “bus” display mode.

You should now see a “bus” display mode showing HEX values of the D7-D0 bus at the bottom of the scope’s display similar to [Figure 31](#). Note that in addition to specifying a pattern trigger condition in a binary format, we can also specify to trigger on a pattern condition as a HEX value. The HEX value of the input to the DAC when the output is at its lowest amplitude is 1A_{HEX}. Let’s now specify to trigger on 1A_{HEX}.

- 18 Press the **[Trigger]** front panel key.
- 19 Press the **Channel** softkey; then select **Bus1** using the Entry knob.
- 20 Press the **Digit** softkey; then select **1** using the Entry knob.
- 21 Press the **Hex** softkey; then select **1** using the Entry knob.
- 22 Press the **Digit** softkey; then select **0** using the Entry knob.
- 23 Press the **Hex** softkey; then select **A** using the Entry knob.

3 Advanced Triggering, Search & Navigation, and Segmented Acquisition Labs

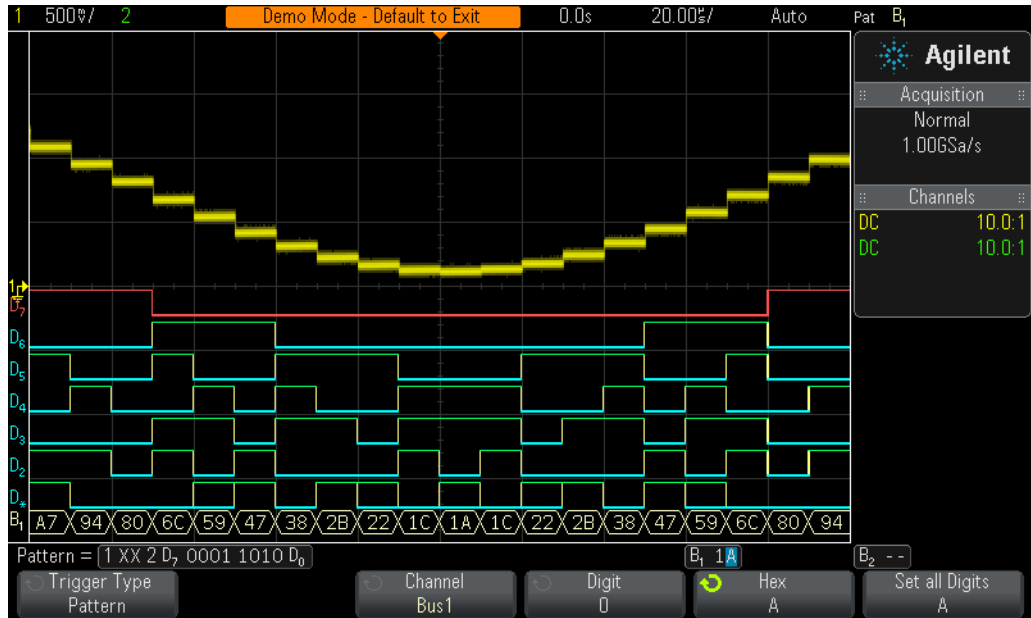
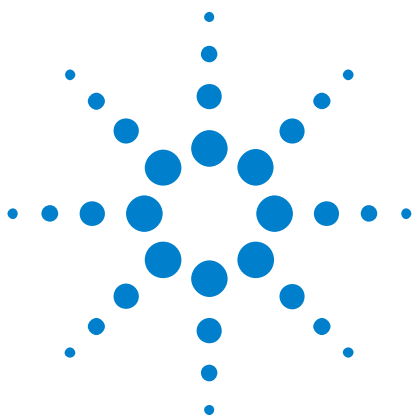

Figure 32 Triggering on pattern = 1A_{HEX}.

Your scope should now be triggering on 1A_{HEX}, which is coincident with the lowest output level of DAC, as shown in [Figure 32](#).



4 Serial Bus Decoding & Triggering, Search & Navigation, and Segmented Acquisition Labs

Lab #10: Decoding, Triggering, and Searching on I2C Serial Bus
Signals [54](#)

Lab #11: Decoding, Triggering, and Searching on SPI Serial Bus
Signals [61](#)

Lab #12: Decoding, Triggering, and Searching on RS232/UART Serial Bus
Signals [67](#)

Lab #13: Decoding, Triggering, and Searching on CAN Serial Bus
Signals [75](#)

Lab #14: Decoding, Triggering, and Searching on LIN Serial Bus
Signals [81](#)



Lab #10: Decoding, Triggering, and Searching on I²C Serial Bus Signals

In this lab you will learn how to set up the scope to decode and trigger on I²C serial bus traffic. In addition, you will learn how to use the scope's automatic I²C Search & Navigation capability, as well as use Segmented Memory acquisition to capture multiple and consecutive occurrences of a particular Read operation. This lab does not provide a tutorial on the I²C protocol and signaling. To complete this lab, your scope must be licensed with the I²C trigger and decode option (Option EMBD). You can verify the installed options on your oscilloscope at **[Help] > About Oscilloscope**.

- 1 Connect the channel-1 probe to the Demo 1 terminal and ground.
- 2 Connect the channel-2 probe to the Demo 2 terminal and ground.
- 3 Press **[Default Setup]** on the scope's front panel.
- 4 Press **[Help]**; then press the **Training Signals** softkey.
- 5 Using the Entry knob, select the **I²C** signal; then press the **Output** softkey to turn it on.
- 6 Set channel-1 to **1.00 V/div**.
- 7 Press the **[2]** front panel key to turn on channel-2.
- 8 Set channel-2 to **1.00 V/div**.
- 9 Set channel-2's offset/position to **+3.50 V**.
- 10 Push the trigger level knob to set the trigger level to approximately **50%**.
- 11 Set the scope's timebase to **500.0 μ s/div**.

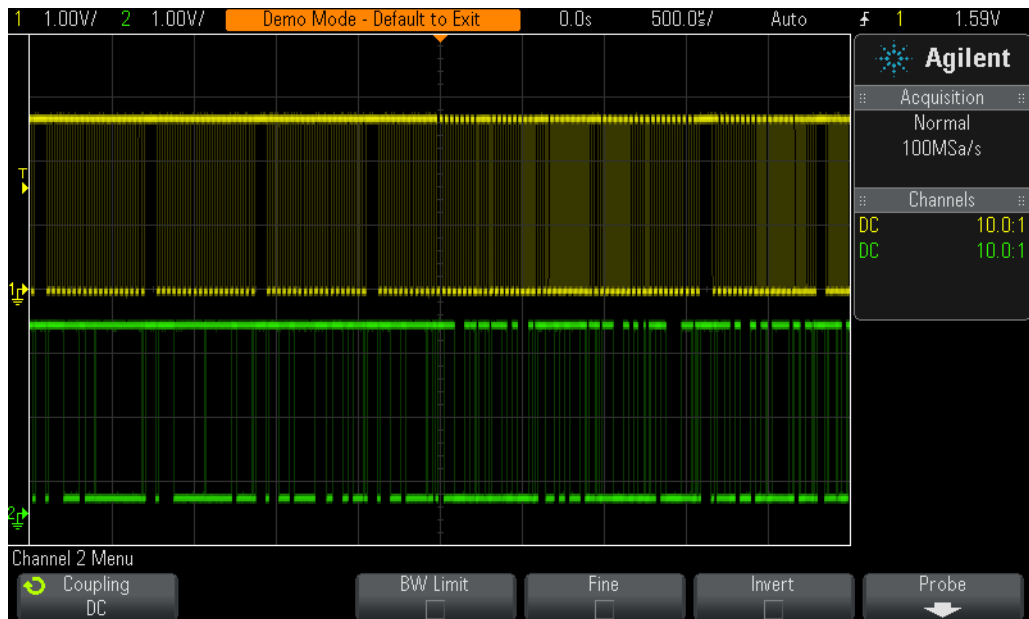



Figure 33 Capturing I²C clock and data while triggering on an edge of the clock (channel-1).

You should see on your scope's display what appears to be an un-triggered display of two digital signals similar to [Figure 33](#). Your scope is actually triggering on random rising edges of channel-1, which is the scope's default trigger condition. But these signals are too complex to establish a unique trigger point using simple edge triggering. The signal being captured by channel-1 is an I²C serial clock signal (SCL), and the signal being captured by channel-2 is an I²C serial data signal (SDA). Let's first set up the scope to intelligently decode this data stream based on the I²C protocol, and then we will establish a more unique trigger point using I²C triggering.

- 12 Press the **[Serial]** front key.
- 13 Press the **Mode** softkey; then select the **I²C** serial decode mode using the Entry.
- 14 Press the **Signals** softkey and verify that **SCL** is defined as channel-1, and that **SDA** is defined as channel-2 (default conditions).
- 15 Press the  (Back) front panel button (above power switch) to return to the previous menu.
- 16 Press the **Addr Size** softkey and verify that **7 Bit** is selected.
- 17 Press the **Lister** softkey; then select to show a list of **Serial 1 (I²C)** using the Entry knob.

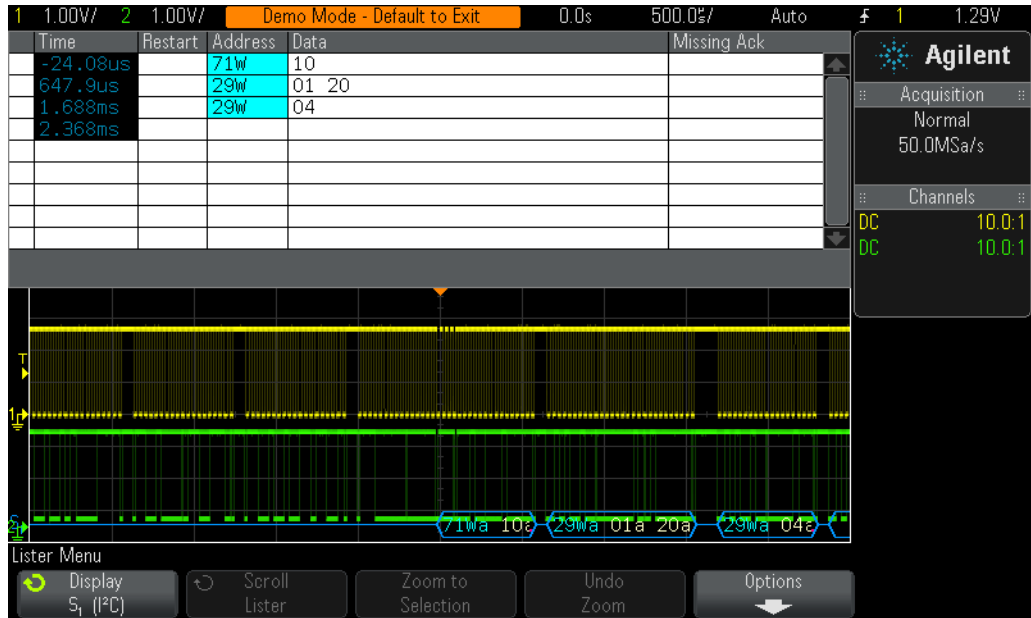

Figure 34 Decoding I²C serial bus traffic.

Your scope should now be decoding I²C serial bus traffic as shown in [Figure 34](#). We can see automatic decoding of this I²C bus in two formats. The blue trace at the bottom of the display shows time-aligned decoding of the serial bus traffic, while the lister table at the top of the display shows I²C decoding in a tabular format.

I²C addresses can be decoded in either an 8-bit or 7-bit format. The MSB of an 8-bit address byte is the READ/WRITE bit, while the lower seven bits define the address. The scope already detects the MSB of the address byte and symbolically decodes it as to whether the address byte is a Read or Write instruction. So the typical address decoding format most engineers prefer is the 7-bit format, which is what we have selected. But you also have the option of seeing the address byte in an 8-bit format, which will include the MSB Read/Write bit.

Note that your scope should still be triggering on random edge crossings of channel-1. Let's now set up the scope to trigger when it detects a Read operation from address = 29_{HEX}, following by an "acknowledge", followed by any data content (don't care).

- 18 Press the **[Trigger]** front panel key; then select **Serial 1 (I²C)** using the Entry knob.
- 19 Press the **Trigger: Start** softkey; then select **Frame(Start:Addr 7:Read:Ack:Data)** using the Entry knob.
- 20 Press the **Address** softkey; then set to **0x29** using the Entry knob.

21 Set the scope's timebase to **200.0 μ s/div**.

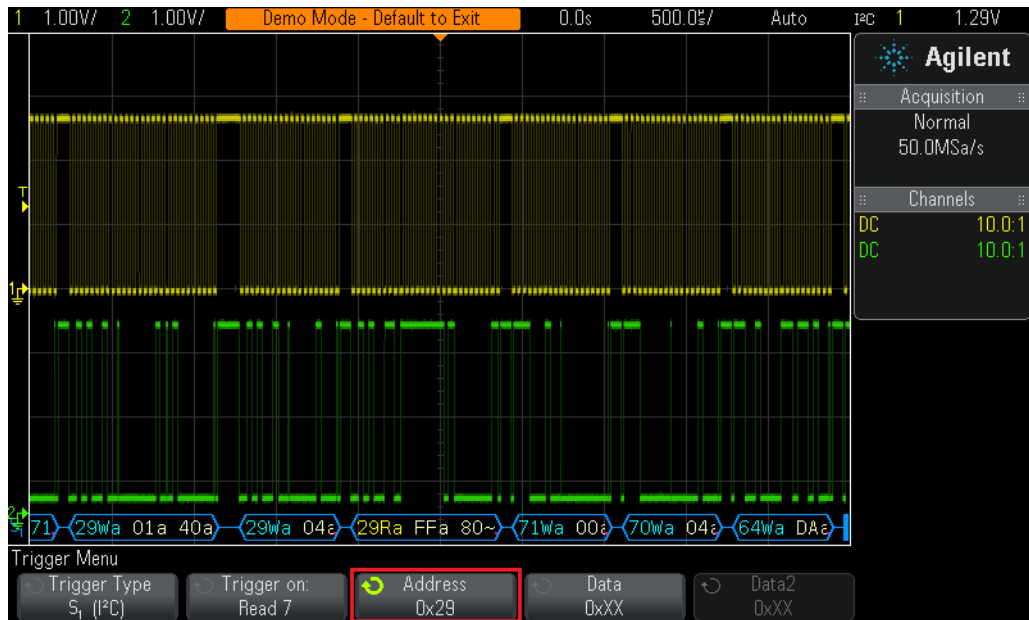

Figure 35 Triggering on I²C traffic.

You should now see stable waveform traces on your scope's display similar to [Figure 35](#). The I²C frame that is near the center of the scope's display, which is the frame that the scope is triggering on, should be decoded as:

< 29RA FFA 80~A > or < 29RA FFA C0~A >

This particular frame should be interpreted as a Read (R) operation from address 29 with an acknowledge (A), followed by a data byte equal to FF with an acknowledge (A), following by a data byte equal to either 80 or C0 without an acknowledge (~A). Let's now capture a very long stream of I²C data and then manually search through the captured and decoded record.

22 Set the scope's timebase to **20.00 ms/div**.

23 Press the [**Serial**] front panel key; then press the **Lister** softkey.

24 Press [**Run/Stop**] to stop repetitive acquisitions.

25 Press the **Scroll Lister** softkey; then turn the Entry knob to manually scroll through the lister table.

As you scroll through the data, note that waveforms “track”. This means that the frame that the arrow points to in the lister table corresponds to the waveforms that are positioned at center-screen. If you want to zoom in on a particular I²C frame, either push the Entry knob, or press the

Zoom to Selection softkey. Let’s now perform an automatic search to find every occurrence of a “Missing Acknowledge”. We will then automatically navigate to each of these occurrences.

- 26 Push the horizontal position/delay knob to re-position the trigger point back to center-screen.
- 27 Set the scope’s timebase to **20.00 ms/div**.
- 28 Press the [**Search**] front panel key.
- 29 Press the **Search Edge** softkey; then select **Serial 1 (I²C)** using the Entry knob.
- 30 Press the **Search for** softkey; then select **Missing Acknowledge** as our search criteria.

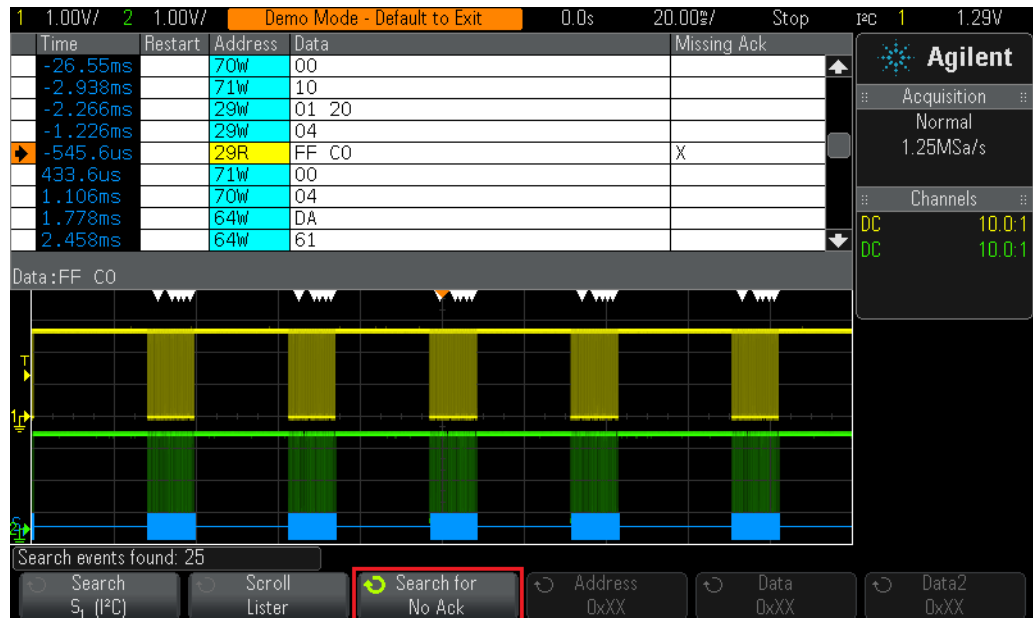

Figure 36 Automatic Search & Navigation.

The white triangles near the top of the waveform area mark the time location of each “found” occurrence of our search operation as shown in [Figure 36](#). These frames are also marked in orange in the first/pointer column of the lister table. Your scope should have found and marked approximately 25 occurrences of this search operation based on a total acquisition time of 200 ms. Note that the number of “found” events is indicated near the bottom of the display. To automatically navigate to each frame with a “Missing Acknowledge”, press the ◀ and ▶ front panel navigation keys near the timebase controls.

Let's now use the scope's Segmented Memory mode of acquisition to selectively capture 25 consecutive occurrences of our trigger condition (Read from address 29_{HEX}). But to complete the rest of this lab your scope must be licensed with the Segmented Memory option.

- 31 Push the horizontal position/delay knob to re-position the trigger point back to center-screen.
- 32 Set the scope's timebase to **100.0 μ s/div**.
- 33 Press the **[Run/Stop]** front panel key to begin repetitive acquisitions again.
- 34 Press the **[Acquire]** front panel key.
- 35 Press the **Segmented** softkey; then turn the Entry knob to select **25** as the number of segments to capture.
- 36 Press the **Segmented** softkey to begin a Segmented Memory acquisition.
- 37 Press the **Current Segment** softkey; then turn the Entry knob to review all 25 captured segments.
- 38 Set the **Current Segment** to **25** and note the time-tag of the last captured segment.

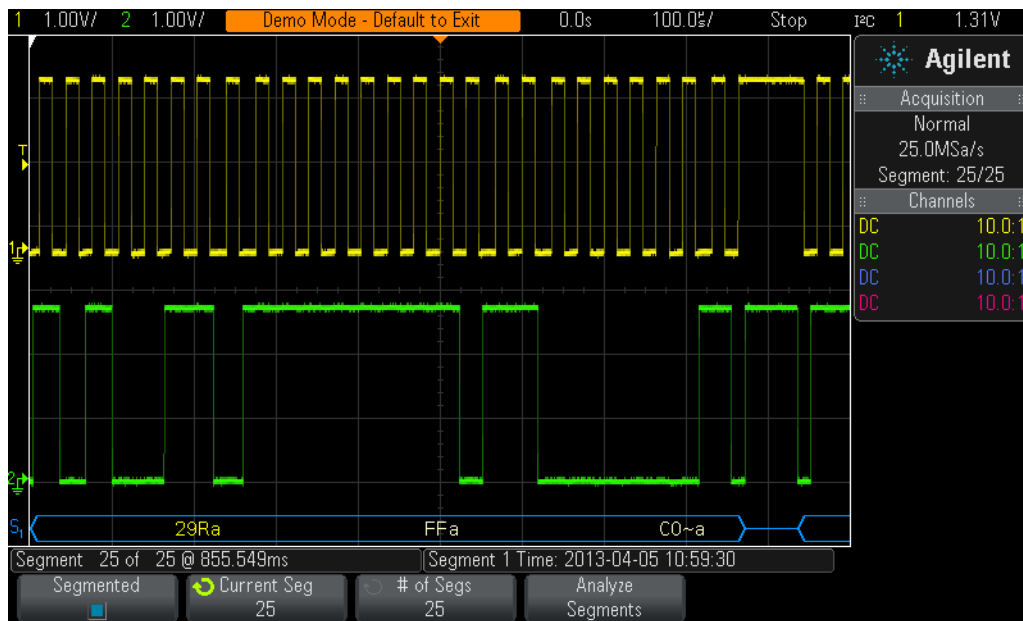

Figure 37 Using the scope's Segmented Memory acquisition to selectively capture more I²C traffic.

Segmented Memory optimizes oscilloscope acquisition memory by only capturing important segments of a waveform based on the trigger condition and timebase setting. In this example, we have selectively captured approximately 860 milliseconds of total acquisition time as shown

4 Serial Bus Decoding & Triggering, Search & Navigation, and Segmented Acquisition Labs

in [Figure 37](#). Note that we can also view the decoded I²C data in the “lister” format, and we can also perform Search & Navigation on the segments.

Lab #11: Decoding, Triggering, and Searching on SPI Serial Bus Signals

In this lab you will learn how to set up the scope to decode and trigger on 2-wire SPI bus serial traffic that utilizes a clock time out for device synchronisation. 2-wire SPI is a form of one-way communication between a master and one slave device, thus not requiring two data lines or a slave select. Note that the 2000 X-Series supports three and four wire SPI as well. In addition, you will learn how to use the scope's automatic SPI Search & Navigation capability, as well as use Segmented Memory acquisition to capture multiple and consecutive occurrences of a particular serial byte. This lab does not provide a tutorial on the SPI protocol and signaling. To complete this lab, your scope must be licensed with the SPI trigger and decode option (Option EMBD), as well as the MSO option. You can verify the installed options on your oscilloscope at **[Help] > About Oscilloscope**.

- 1 Press **[Default Setup]** on the scope's front panel.
- 2 Press **[Help]**; then press the **Training Signals** softkey.
- 3 Using the Entry knob, select the **SPI** signal; then press the **Output** softkey to turn it on.
- 4 Set channel-1 to **1.00 V/div**.
- 5 5 Set channel-1's offset/position to **-1.00 V**.
- 6 6 Press the **[2]** front panel key to turn on channel-2.
- 7 7 Set channel-2 to **1.00 V/div**.
- 8 8 Set channel-2's offset/position to **+2.50 V**.
- 9 Set the scope's timebase to **200.0 μ s/div**.

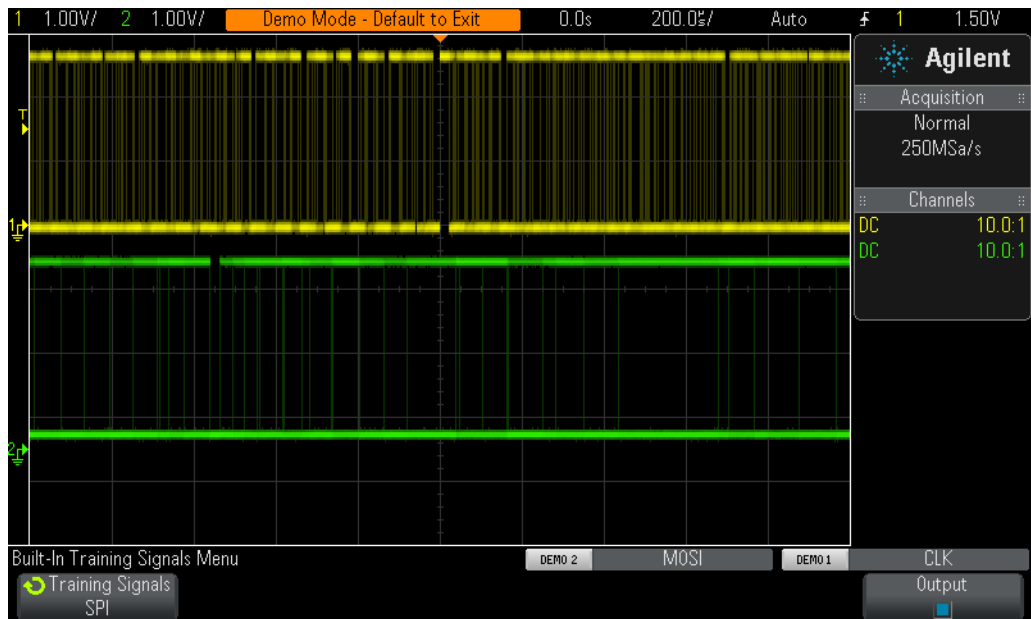

Figure 38 Capturing 2-wire SPI signals.

You should now see two digital waveforms captured by the scope's digital channels of acquisition similar to [Figure 38](#).

Channel-1 is the SPI clock signal (CLK) and Channel-2 is the MOSI/MISO data signal. Let's now set up the scope to decode these SPI signals.

- 10 Press the **[Serial]** front panel key.
- 11 Press the **Mode I²C** softkey; then select **SPI** using the Entry knob.
- 12 Press the **Signals** softkey.
- 13 Press the **Clock** softkey; then press **Threshold** and adjust to **+1.20 V** using the Entry knob.
- 14 Press the **(Back)** front panel button to return to the previous menu.
- 15 Press the **MOSI** softkey; then press **Threshold** and adjust to **+1.60 V** using the Entry knob.
- 16 Press the **(Back)** front panel button to return to the previous menu.
- 17 Press the **CS** softkey; then press the **Timeout** softkey; then enter **1.00 ms** using the Entry knob.
- 18 Press the **[Label]** front panel key to turn on the scope's default labels.

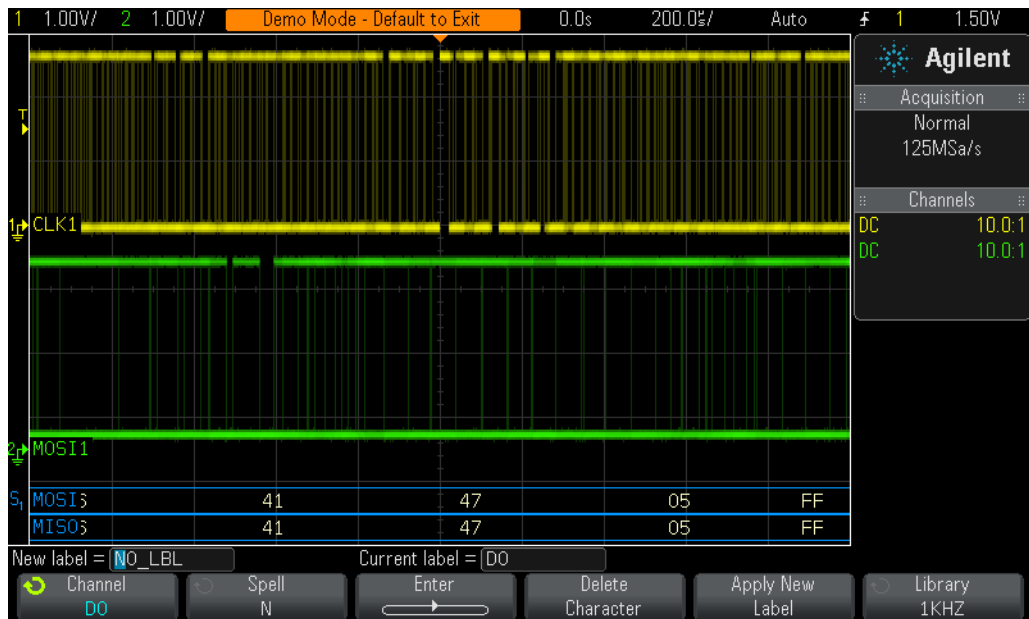

Figure 39 Decoding a 2-wire SPI serial bus.

Your scope should now be decoding the MOSI/MISO serial data line similar to [Figure 39](#). However, the scope is not yet triggering on these signals. The scope's default trigger condition is to trigger on a rising edge of channel-1. Let's now set up the scope to trigger on a MOSI data byte equal to 0000 0011 (03_{HEX}).

- 19 Press the **[Trigger]** front panel key; then select **Serial 1 (SPI)** using the Entry knob.
- 20 Press the **Trigger Setup** softkey.
- 21 Press the **Bit** softkey; then turn the Entry knob to select the MSB (left-most bit), which is Bit 0.
- 22 Press the **0 1 X** softkey to select **0** as the trigger logic condition for Bit 0 (MSB).
- 23 Press the **Bit** softkey to increment to the Bit 1 position.
- 24 Press the **0 1 X** softkey to select **0** for Bit 1.
- 25 Repeat Steps #23 and #24 until MOSI Data = 0000 0011.



Figure 40 Triggering on MOSI data = 03_{HEX}.

Your scope should now be triggering on MOSI data = 03_{HEX} with this byte shown at center-screen similar to [Figure 40](#). Let's now capture a very long stream of SPI traffic and then manually search through the captured and decoded record.

- 26 Press the **[Serial]** front panel key.
- 27 Press the **Lister** softkey; then turn the Entry knob to select **Serial 1 (SPI)**.
- 28 Set the scope's timebase to **20.00 ms/div**.
- 29 Press **[Run/Stop]** to stop repetitive acquisitions.
- 30 Press the **Scroll Lister** softkey; then turn the Entry knob to manually scroll through the lister table.

As you scroll through the data, note that waveforms "track". This means that the frame that the arrow points to in the lister table corresponds to the waveforms that are positioned at center-screen. If you want to zoom in on a particular SPI frame of data, either push the Entry knob, or press the **Zoom to Selection** softkey. Let's now perform an automatic search to find every occurrence of MOSI data = 03 20_{HEX}. We will then automatically navigate to each of these occurrences.

- 31 Push the horizontal position/delay knob to re-position the trigger point back to center-screen.
- 32 Set the scope's timebase to **20.00 ms/div**.
- 33 Press the **[Search]** front panel key.
- 34 Press the **Search Edge** softkey; then select **Serial 1 (SPI)**.

- 35 Press the **Bits** softkey.
- 36 Press the **Words** softkey; then enter **2** using the entry knob.
- 37 Press the **Select Digit** softkey; then select the upper nibble (left-most nibble).
- 38 Press the **Hex** softkey; then turn the Entry knob to select **0**.
- 39 Press the **Select Digit** softkey; then turn the Entry knob to select lower nibble.
- 40 Press the **Hex** softkey; then turn the Entry knob to select **3**.
- 41 Repeat this process until the **Data** field reads **03 20**.

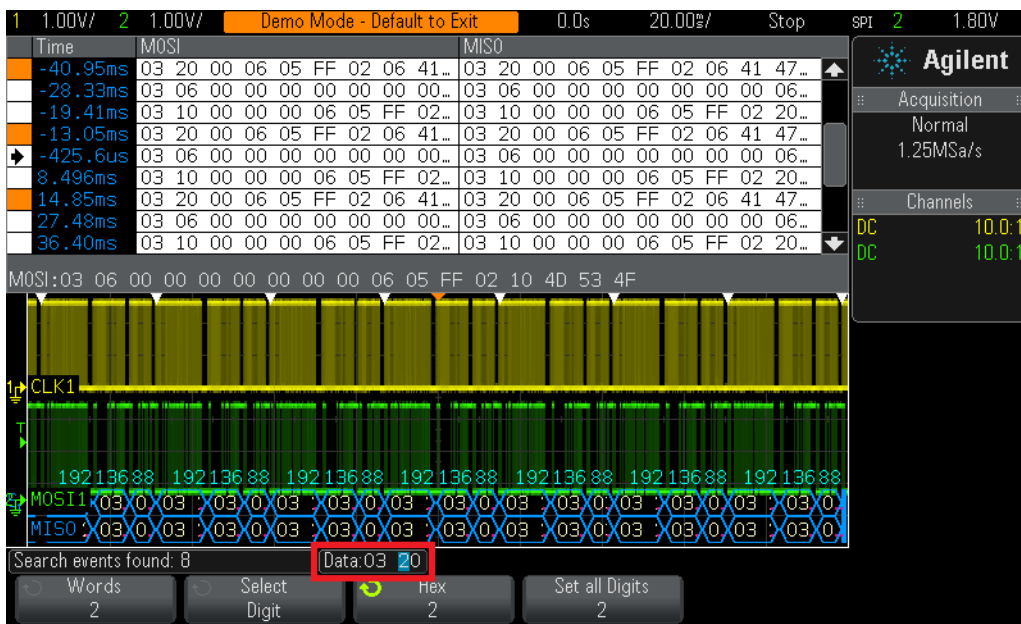

Figure 41 Automatic Search & Navigation on SPI traffic.

The white triangles near the top of the waveform area mark the time location of each “found” occurrence of our search operation as shown in [Figure 41](#). These frames are also marked in orange in the first/pointer column of the lister table. Your scope should have found and marked approximately 8 occurrences of this search operation based on a total acquisition time of 200 ms. Note that the number of “found” events is indicated near the bottom of the display. To automatically navigate to each MOSI byte = $03\ 20_{\text{HEX}}$, press the \leftarrow and \rightarrow front panel navigation keys.

Let’s now use the scope’s Segmented Memory mode of acquisition to capture 25 consecutive occurrences of SPI serial bus traffic when MOSI = $03\ 20_{\text{HEX}}$. But to complete the rest of this lab your scope must be licensed with the Segmented Memory option.

4 Serial Bus Decoding & Triggering, Search & Navigation, and Segmented Acquisition Labs

- 42 Push the horizontal position/delay knob to re-position the trigger point back to center-screen.
- 43 Set the scope's timebase to **200.0 μ s/div**.
- 44 Press the **[Run/Stop]** front panel to begin repetitive acquisition again.
- 45 Press the **[Acquire]** front panel key.
- 46 Press the **Segmented** softkey; then turn the Entry knob to select **25** as the number of segments to capture.
- 47 Press the **Segmented** softkey to begin a Segmented Memory acquisition.
- 48 Press the **Current Segment** softkey; then turn the Entry knob to review all 25 captured segments.
- 49 Set the **Current Segment** to **25** and note the time-tag of the last captured segment.

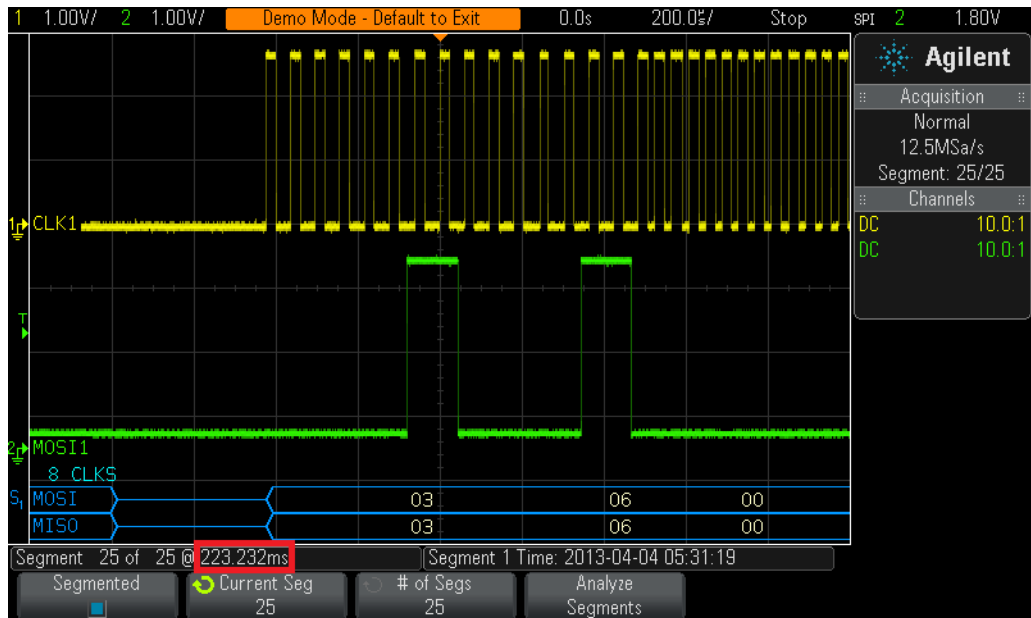

Figure 42 Using the scope's Segmented Memory acquisition to selectively capture more SPI traffic.

Segmented Memory optimizes oscilloscope acquisition memory by only capturing important segments of a waveform based on the trigger condition and timebase setting. In this example, we have selectively captured over 200 milliseconds of total acquisition time as shown in [Figure 42](#). Note that we can also view the decoded SPI data in the “lister” format, and we can also perform Search & Navigation on the segments.

Lab #12: Decoding, Triggering, and Searching on RS232/UART Serial Bus Signals

In this lab you will learn how to set up the scope to decode and trigger on transmit and receive RS232/UART serial bus traffic. In addition, you will learn how to use the scope's automatic RS232/UART Search & Navigation capability, as well as Segmented Memory acquisition. This lab does not provide a tutorial on the RS232/UART protocols and signaling. To complete this lab, your scope must be licensed with the RS232/UART trigger and decode option (Option COMP). You can verify the installed options on your oscilloscope at **[Help] > About Oscilloscope**.

- 1 Connect the channel-1 probe to the Demo 1 terminal and ground.
- 2 Connect the channel-2 probe to the Demo 2 terminal and ground.
- 3 Press **[Default Setup]** on the scope's front panel.
- 4 Press **[Help]**; then press the **Training Signals** softkey.
- 5 Using the Entry knob, select the **RS232/UART** signal; then press the **Output** softkey to turn it on.
- 6 Set channel-1 to **1.00 V/div**.
- 7 Set channel-1's offset/position to **-1 V**.
- 8 Press the **[2]** front panel key to turn on channel-2.
- 9 Set channel-2 to **1.00 V/div**.
- 10 Set channel-2's offset/position to **+2.3 V**.
- 11 Push the trigger level knob to automatically set the trigger level to approximately **50%**.
- 12 Set the scope's timebase to **2.00 ms/div**.

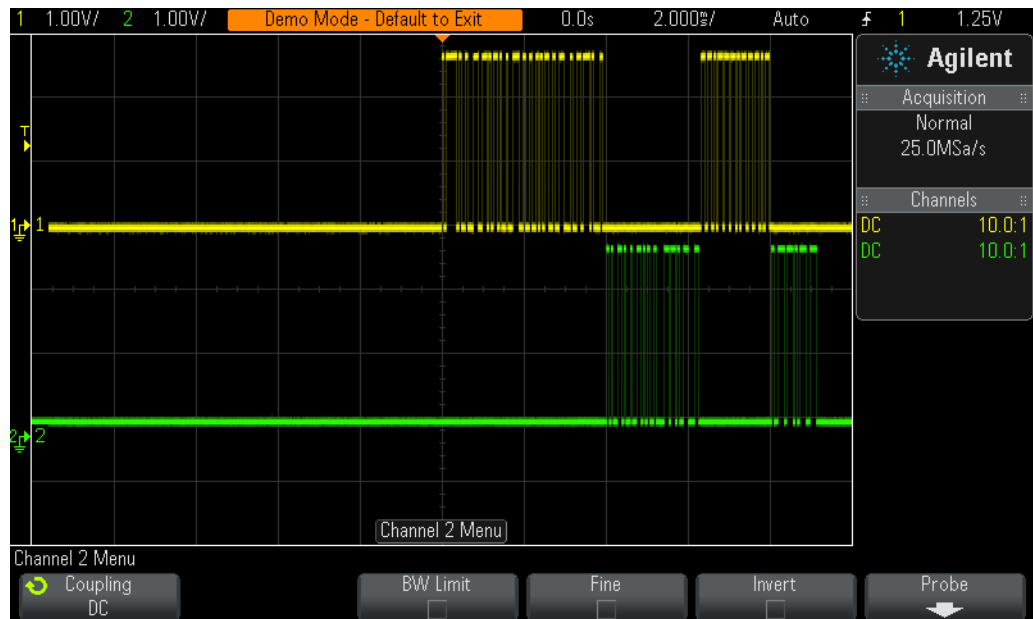

Figure 43 Capturing RS232/UART transmit and receive data signals using the scope's Edge triggering mode.

You should now see on your scope's display what appears to be an un-triggered display of two digital signals similar to [Figure 43](#). Your scope is actually triggering on random rising edges of channel-1, which is the scope's default trigger condition. But these signals are too complex to establish a unique trigger point using simple edge triggering. The signal captured by channel-1 is an RS232 serial receive data signal (RX), and the signal captured by channel-2 is an RS232 serial transmit data signal (TX). Let's first set up the scope to intelligently decode this data stream based on the RS232/UART protocol, and then we will establish a more unique trigger point using RS232/UART triggering.

- 13 Press the **[Serial]** front panel key.
- 14 Press the **Mode I²C** softkey; then select the **UART/RS232** serial decode mode using the Entry knob.
- 15 Press the **Signals** softkey and verify that **Rx** is defined as channel-1, and that **Tx** is defined as channel-2 (default conditions).
- 16 Press the **(Back)** front panel button (above power switch) to return to the previous menu.
- 17 Press the **Bus Config** softkey.
- 18 Press the **Parity** softkey; then select **Odd**.
- 19 While this menu is active, also verify that the # of Bits is set to **8**, the Baud Rate is set to **19.2 kb/s**, Polarity is set to **Idle Low**, and Bit Order is set to **LSB** first.

- 20 Press the **[Label]** front panel key (between channel-1 and channel-2 controls) to turn on the scope's default labels.

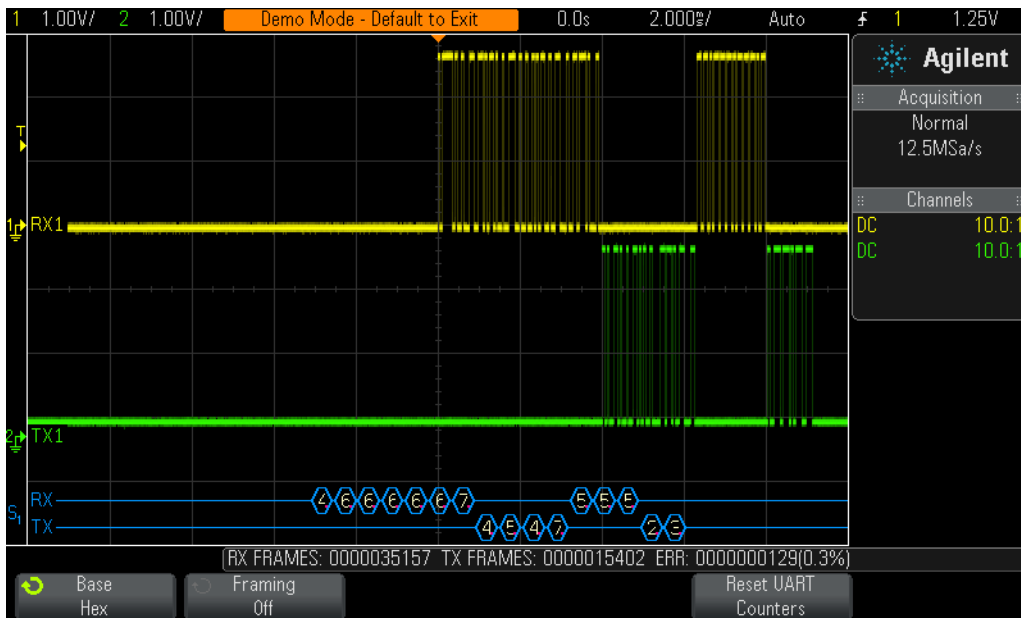

Figure 44 Decoding the RS232/UART serial bus.

You should now see RS232/UART decoding of these signals on your scope's display similar to [Figure 44](#), but we still haven't established stable triggering. The scope is still triggering on any rising edge of channel-1 (default trigger condition). Let's now set up the scope to trigger when the transmit data signal (TX) is equal to 4D_{HEX}.

- 21 Press the **[Trigger]** front panel key; then select **Serial 1 (UART/RS232)** using the Entry knob.
- 22 Press the **Trigger Setup** softkey; then select **Tx Data** using the Entry knob.
- 23 Press the **Data** softkey; then select **0x4D** using the Entry knob.
- 24 Set the scope's timebase to **1.000 ms/div**.

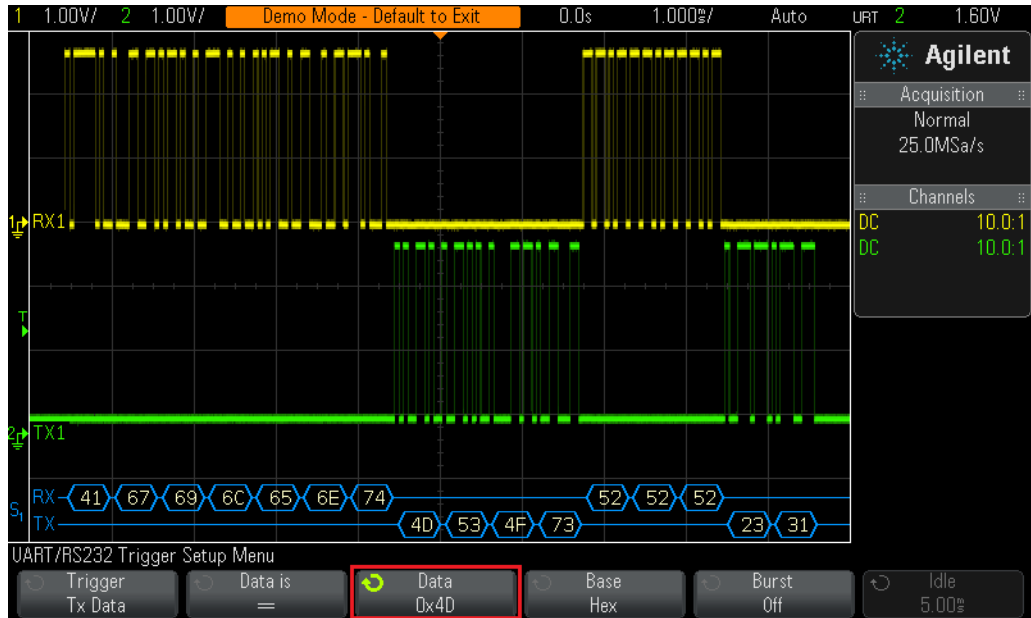

Figure 45 Triggering on Tx = 4D_{HEX}.

Your scope should now be triggering on Tx = 4D_{HEX} while displaying this byte at center-screen similar to [Figure 45](#). Let’s now set up the scope to capture a longer record of time (2 seconds) and review our data in a “lister” format.

- 25 Set the scope’s timebase to **200.0 ms/div**.
- 26 Press **[Run/Stop]** to stop repetitive acquisitions.
- 27 Press the **[Serial]** front panel key.
- 28 Press the **Lister** softkey; then select **Serial 1 (UART/RS232)** using the Entry knob.
- 29 Press the **Scroll Lister** softkey; then turn the Entry knob to scroll through the decoded data.

As you scroll through the data, note that waveforms “track”. This means that the frame that the arrow points to in the lister table corresponds to the waveforms that are positioned at center-screen. If you want to zoom in on a particular RS232/UART byte of data, either push the Entry knob, or press the **Zoom to Selection** softkey. This particular stream of RS232/UART data includes some infrequent parity errors (marked in red). But locating the occasional parity bit error conditions can be difficult using the manual scrolling method if the parity bit errors are very infrequent. So let’s now perform an automatic search to find every occurrence of parity bit errors on both the Tx and Rx data lines. We will then automatically navigate to each of these occurrences.

- 30 Push the horizontal position/delay knob to re-position the trigger point back to center-screen.
- 31 Set the scope's timebase to **200.0 ms/div**.
- 32 Press the [**Search**] front panel key.
- 33 Press the **Search Edge** softkey; then select **Serial 1 (UART/RS232)**.
- 34 Press the **Search for** softkey; then select **Rx or Tx Parity Error** using the Entry knob.

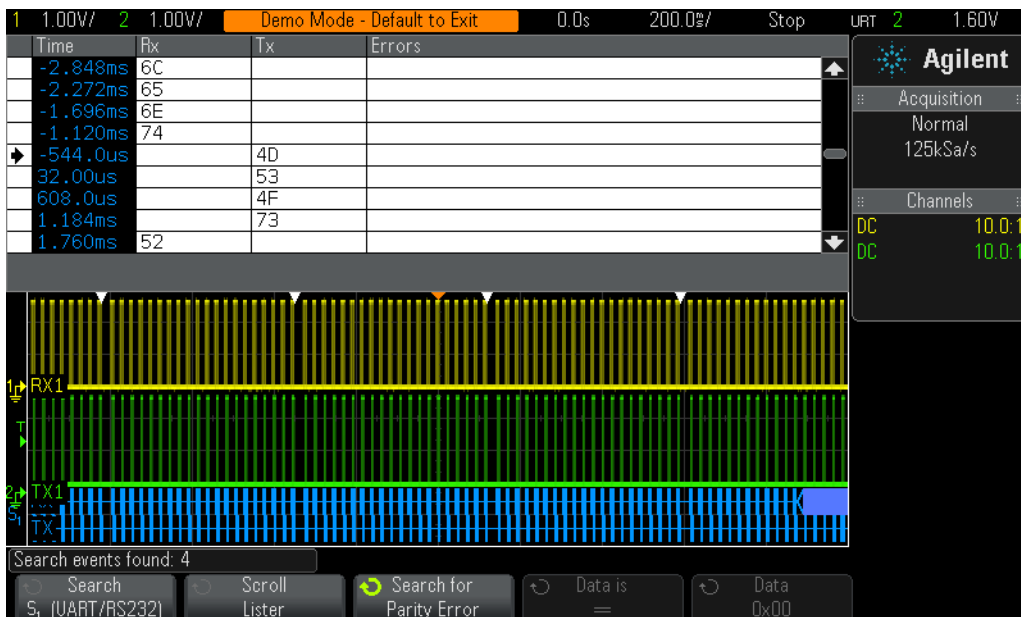

Figure 46 Using the scope's automatic Search & Navigation capability to find all occurrences of parity bit errors over a 2 second time span.

The white triangles near the top of the waveform area mark the time location of each “found” occurrence of our search operation as shown in [Figure 46](#). These frames are also marked in orange in the first/pointer column of the lister table. Your scope should have found and marked 4 or 5 occurrences of this search operation based on a total acquisition time of 2 seconds. Note that the number of “found” events is indicated near the bottom of the display. To automatically navigate to each parity bit error, press the ◀ and ▶ front panel navigation keys.

Let's now set up the scope to trigger exclusively on parity errors. But because these errors occur so infrequently, we will need to change the trigger mode from Auto to Normal to prevent auto triggering.

- 35 Push the horizontal position/delay knob to re-position the trigger point back to center-screen.
- 36 Set the scope's timebase to **1.00 ms/div**.

- 37 Press the **[Run/Stop]** front panel to begin repetitive acquisitions again.
- 38 Press the **[Trigger]** front panel key; then press the **Trigger Setup** softkey.
- 39 Press the **Trigger Tx Data** softkey; then select **Rx or Tx Parity Error**.
- 40 Press the **[Mode/Coupling]** front panel key near the trigger level knob.
- 41 Press the **Mode Auto** softkey; then select **Normal**.
- 42 Set the horizontal position/delay to approximately **-4.7 ms**.

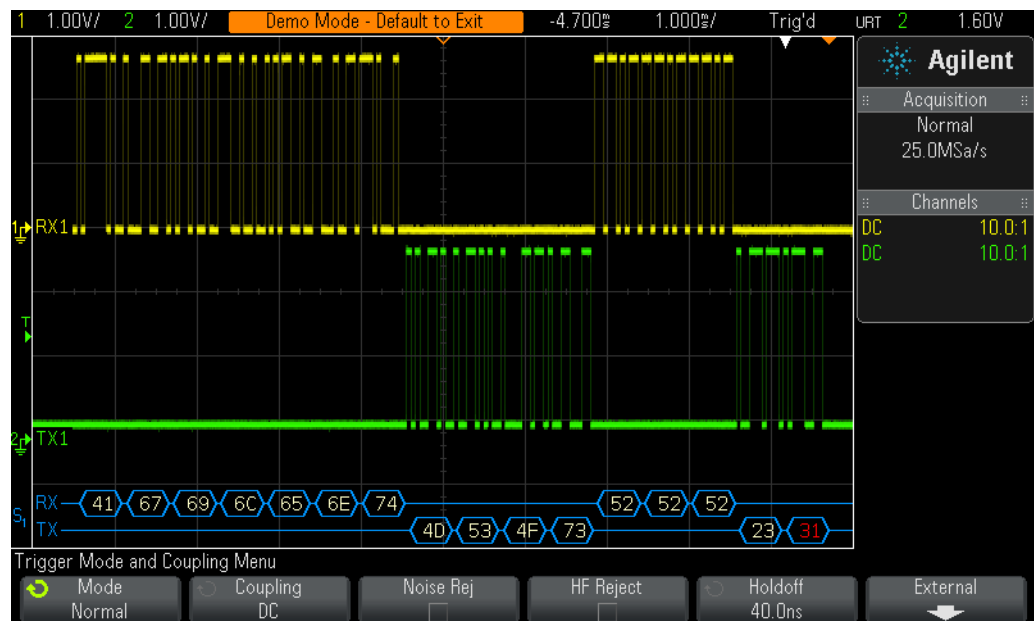

Figure 47 Triggering on Parity Errors.

We now have the scope triggering exclusively on parity errors (note that “31” is displayed in red) as shown in [Figure 47](#). Let’s now use the scope’s Segmented Memory acquisition to capture 25 consecutive occurrences of parity errors. We will then review the captured errors to determine how often they occur. But to complete the rest of this lab your scope must be licensed with the Segmented Memory option.

- 43 Press the **[Acquire]** front panel key.
- 44 Press the **Segmented** softkey; then turn the Entry knob to select **25** as the number of segments to capture.
- 45 Press the **Segmented** softkey to begin a Segmented Memory acquisition (be patient... these errors occur very infrequently).
- 46 When the scope finishes capturing 25 segments, press the **Current Segment** softkey; then turn the Entry knob to review all 25 captured segments and note the time between each event.

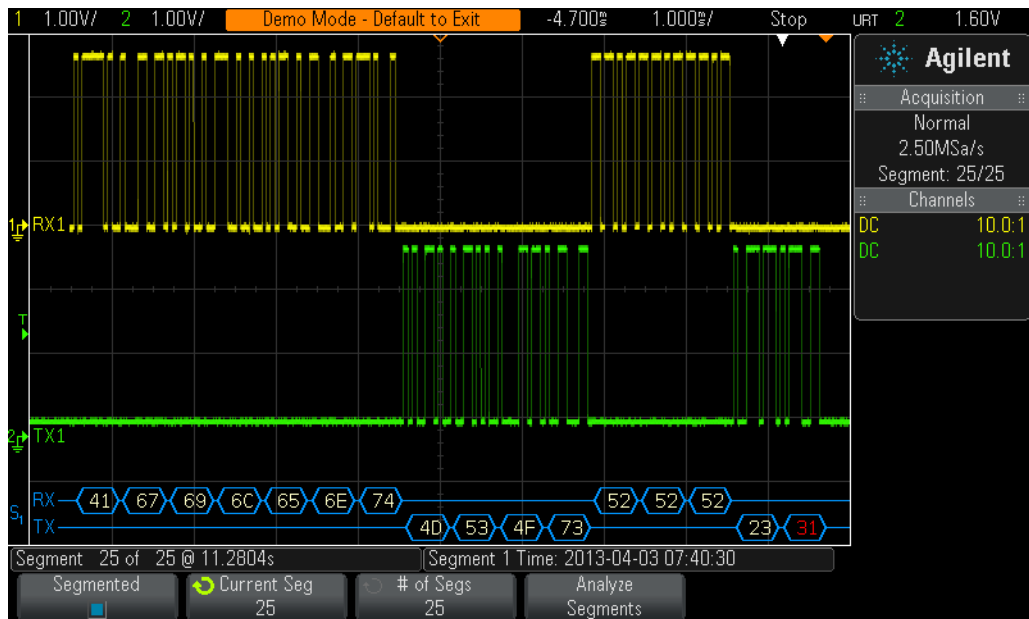

Figure 48 Using the scope’s Segmented Memory acquisition to selectively capture 25 occurrences of Parity Errors.

Segmented Memory optimizes oscilloscope acquisition memory by only capturing important segments of a waveform based on the trigger condition and timebase setting. In this example, we have selectively captured just bursts of data that include a parity error over a time-span exceeding 11 seconds as shown in [Figure 48](#).

Note that although not shown and demonstrated, we can also view the segmented decoded RS232/UART serial data in the “lister” format, and we can also perform Search & Navigation on the segments. Let’s now view this decoded RS232/UART in a different numeric format to uncover an important Agilent marketing message.

47 Press the **[Serial]** front panel key; then press the **Settings** softkey

48 Press the **Base** softkey; then select **ASCII**.

4 Serial Bus Decoding & Triggering, Search & Navigation, and Segmented Acquisition Labs

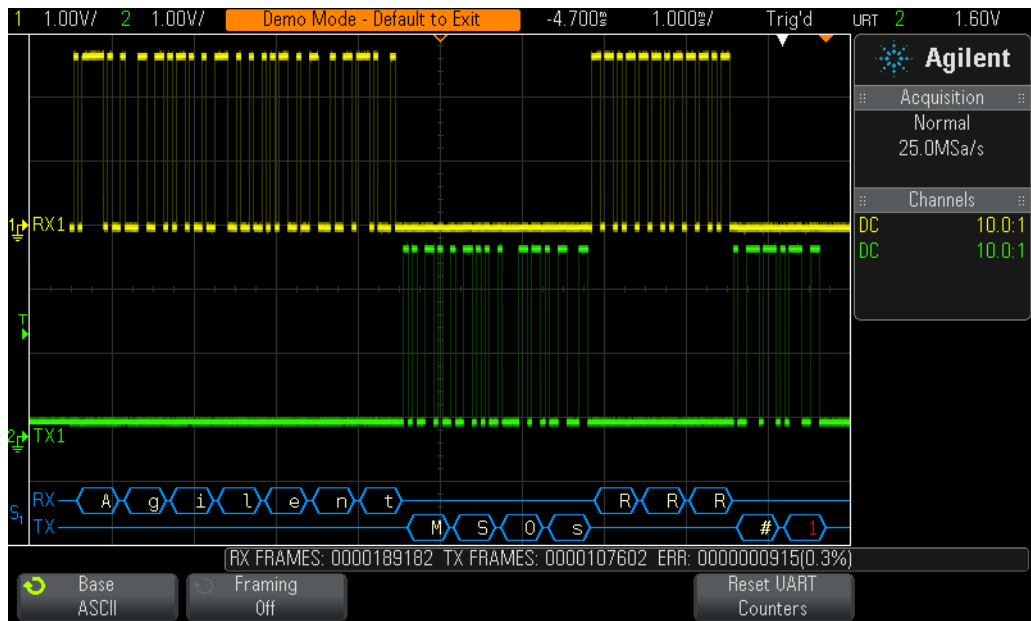

Figure 49 Decoded RS232/UART message indicating which oscilloscope vendor is #1 in the MSO market.

Lab #13: Decoding, Triggering, and Searching on CAN Serial Bus Signals

In this lab you will learn how to set up the scope to decode and trigger on a CAN serial bus signal. In addition, you will learn how to use the scope's automatic CAN Search & Navigation capability, as well as Segmented Memory acquisition. This lab does not provide a tutorial on the CAN protocol and signaling. To complete this lab, your scope must be licensed with the CAN/LIN trigger and decode option (Option AUTO). You can verify the installed options on your oscilloscope at [Help] > About Oscilloscope.

- 1 Connect the channel-1 probe to the Demo 1 terminal and ground.
- 2 Press [Default Setup] on the scope's front panel.
- 3 Press [Help]; then press the **Training Signals** softkey.
- 4 Using the Entry knob, select the **CAN** signal; then press the **Output** softkey to turn it on.
- 5 Set channel-1 to **500.0 mV/div**.
- 6 Set channel-1's offset/position to **+1.4 V**.
- 7 Push the trigger level knob to automatically set the trigger level to approximately **50%**.
- 8 Set the scope's timebase to **100.0 μ s/div**.

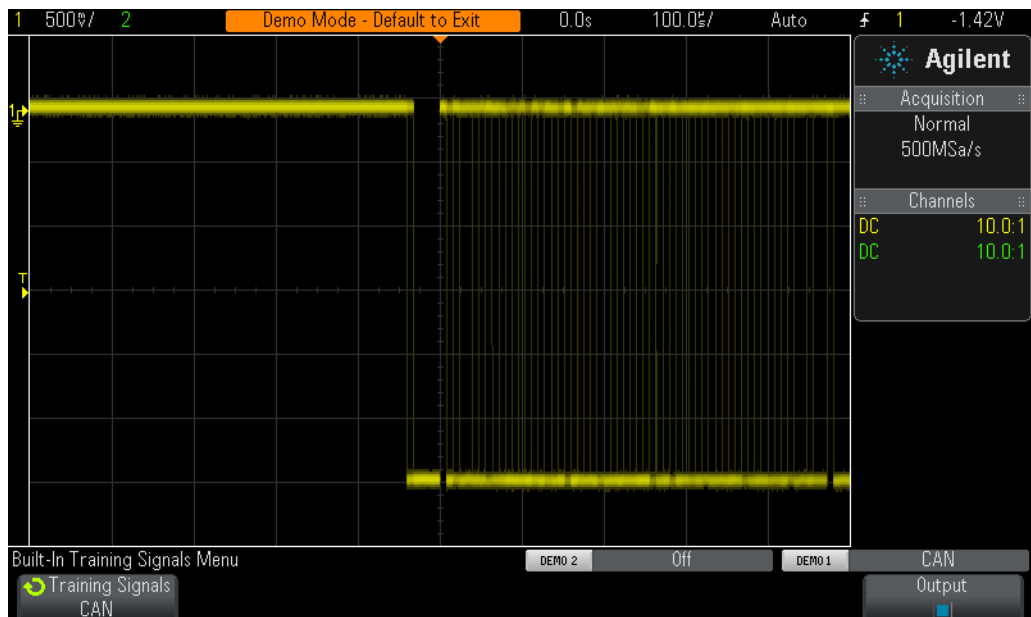

Figure 50 Capturing a CAN frame using the scope's Edge triggering mode.

4 Serial Bus Decoding & Triggering, Search & Navigation, and Segmented Acquisition Labs

You should now see on your scope's display what appears to be an un-triggered display of a digital burst signal similar to [Figure 50](#). Your scope is actually triggering on random rising edges of channel-1, which is the scope's default trigger condition. But this signal is too complex to establish a unique trigger point using simple edge triggering. This signal is a packet/frame of CAN serial bus traffic. Let's first set up the scope to intelligently decode this data stream based on the CAN protocol, and then we will establish a more unique trigger point using CAN triggering.

- 9 Press the **[Serial]** front panel key.
- 10 Press the **Mode I²C** softkey; then select the **CAN** serial decode mode using the Entry knob.
- 11 Press the **Signals** softkey; then select **CAN_L**.
- 12 With the Signals menu active, also verify that the input **Source** is defined as channel-1 and the baud rate is set to **125 kb/s** (default conditions).

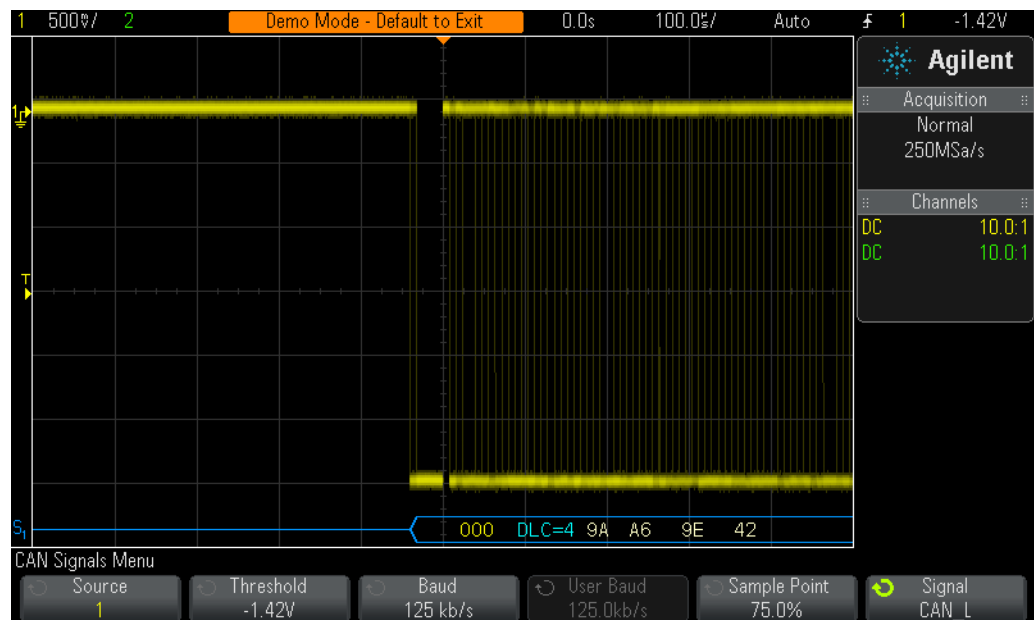

Figure 51 Decoding a CAN bus while triggering on any rising edge of the input signal.

You should now see CAN decoding of this signal on your scope's display similar to [Figure 51](#), but we still haven't established stable triggering. The scope is still triggering on any rising edge of channel-1 (default trigger condition). Let's now set up the scope to trigger on a CAN data frame with the ID = 07F_{HEX}.

- 13 Press the **[Trigger]** front panel key.
- 14 Select **Serial 1 (CAN)** using the Entry knob.

- 15 Press **Trigger: SOF**; then select **Data Frame ID (~RTR)** using the Entry knob.
- 16 Press the **Bits** softkey.
- 17 Press the **Hex** softkey; then select **F** using the Entry knob.

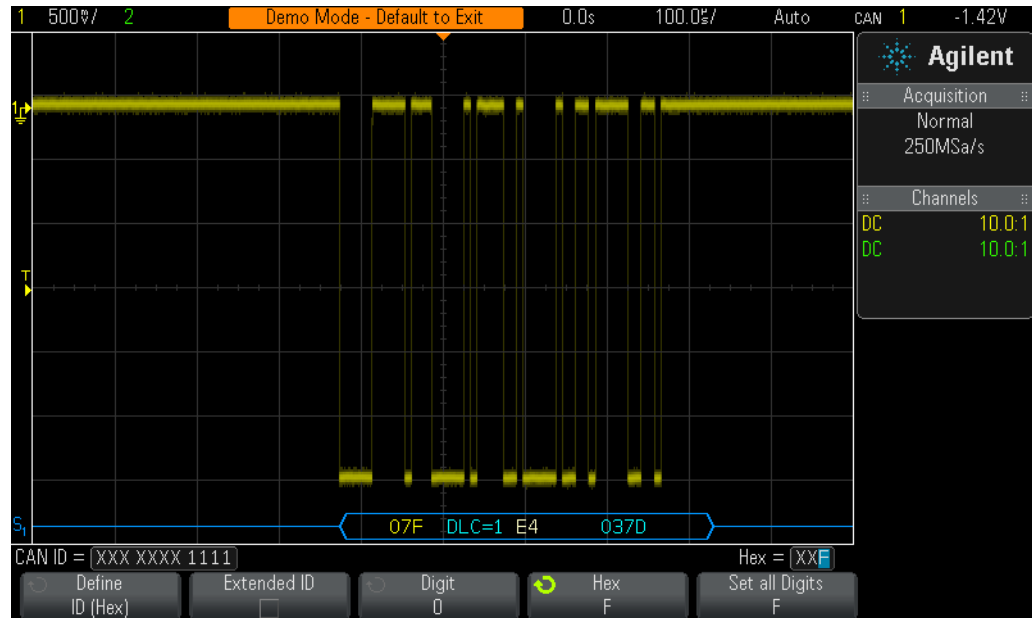

Figure 52 While triggering on CAN data frame = $07F_{\text{HEX}}$, the scope’s hardware-based decoding reveals infrequent error conditions.

Your scope should now be triggering on CAN data frame = $07F_{\text{HEX}}$ as shown in [Figure 52](#). With this scope’s very fast hardware-based decoding, you should also see some decoded red “flashing” near the end of this packet/frame of data. This is an indication that the scope is capturing and quickly decoding infrequent Error Frames. Let’s now capture a very long stream of CAN traffic (1 second of acquisition time) and then manually search through the captured and decoded record.

- 18 Press the **[Serial]** front panel key.
- 19 Press the **Lister** softkey; then turn the Entry knob to select **Serial 1 (CAN)**.
- 20 Set the scope’s timebase to **100.00 ms/div**.
- 21 Press **[Run/Stop]** to stop repetitive acquisitions.
- 22 Press the **Scroll Lister** softkey; then turn the Entry knob to manually scroll through the lister table.

As you scroll through the data, note that waveforms “track”. This means that the frame that the arrow points to in the lister table corresponds to the waveforms that are positioned at center-screen. If you want to zoom in on a particular CAN frame of data, either push the Entry knob, or press the **Zoom to Selection** softkey. Looking for infrequent errors in this

long decoded record can be difficult. So let’s now perform an automatic search to find all occurrences of Error Frames and “form” errors (non-flagged error conditions). We will then automatically navigate to each of these error conditions.

- 23 Push the horizontal position/delay knob to re-position the trigger point back to center-screen.
- 24 Set the scope’s timebase to **100.0 ms/div**.
- 25 Press the **[Search]** front panel key.
- 26 Press the **Search Edge** softkey; then select **Serial 1 (CAN)**.
- 27 Press the **Search for** softkey; then select **All Errors** using the Entry knob.

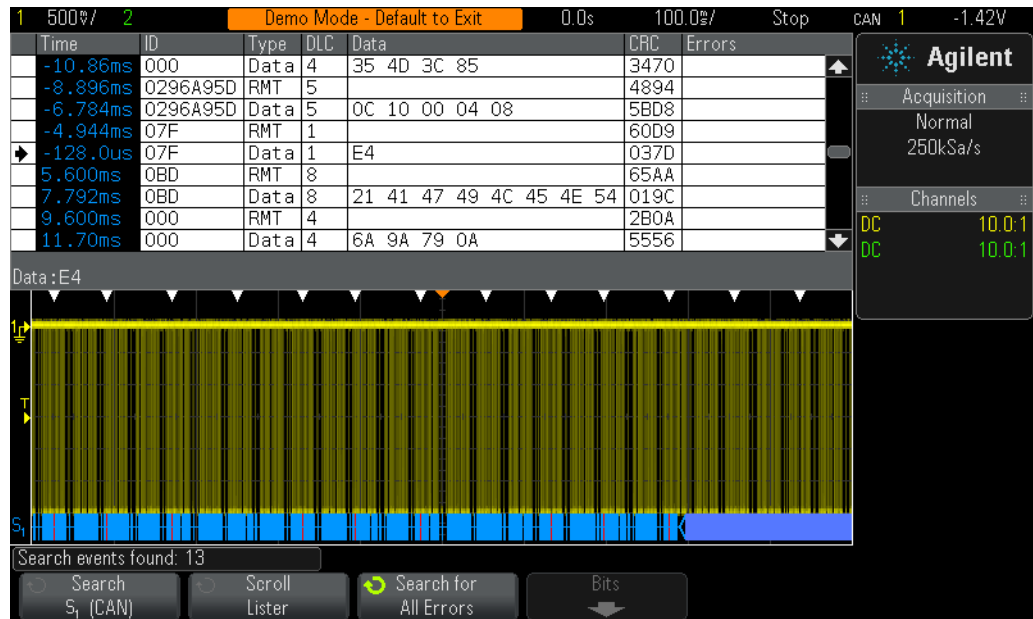

Figure 53 Using the scope’s automatic Search & Navigation capability to find all occurrences of CAN errors over a 1 second time span.

The white triangles near the top of the waveform area mark the time location of each “found” occurrence of our search operation as shown in [Figure 53](#). These frames are also marked in orange in the first/pointer column of the lister table. Your scope should have found and marked more than 10 occurrences of this search operation based on a total acquisition time of 1 second. Note that the number of “found” events is indicated near the bottom of the display. To automatically navigate to each CAN error, press the ◀ and ▶ front panel navigation keys.

Let's now use the scope's Segmented Memory mode of acquisition to capture 25 consecutive occurrences of CAN error conditions. But to complete the rest of this lab your scope must be licensed with the Segmented Memory option.

- 28 Push the horizontal position/delay knob to re-position the trigger point back to center-screen.
- 29 Set the scope's timebase to **200.0 μ s/div**.
- 30 Press the **[Run/Stop]** front panel to begin repetitive acquisition again.
- 31 Press the **[Trigger]** front panel key.
- 32 Press the **Trigger: ID & ~RTR** softkey; then select **All Errors** using the Entry knob.
- 33 Press the **[Mode/Coupling]** key in the Trigger section of the front panel; then select the **Normal** trigger mode.
- 34 Press the **[Acquire]** front panel key.
- 35 Press the **Segmented** softkey; then turn the Entry knob to select **25** as the number of segments to capture.
- 36 Press the **Segmented** softkey to begin a Segmented Memory acquisition.
- 37 Press the **Current Segment** softkey; then turn the Entry knob to review all 25 captured segments.
- 38 Set the **Current Segment** to **25** and note the time-tag of the last captured segment.

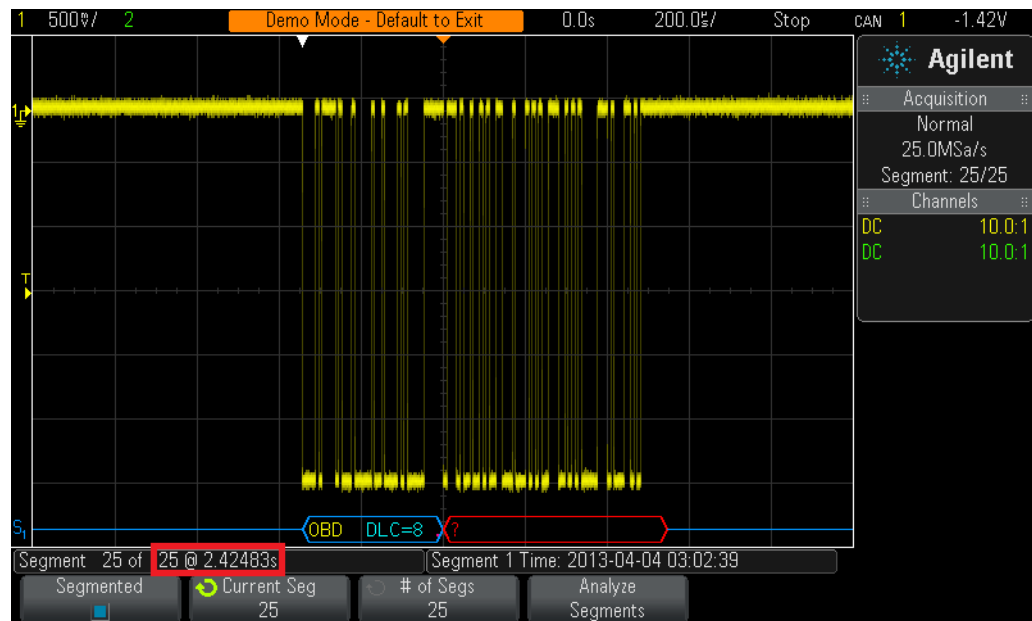

Figure 54 Using the scope's Segmented Memory acquisition to selectively capture 100 CAN error conditions.

4 Serial Bus Decoding & Triggering, Search & Navigation, and Segmented Acquisition Labs

Segmented Memory optimizes oscilloscope acquisition memory by only capturing important segments of a waveform based on the trigger condition and timebase setting. In this example, we have selectively captured approximately 2.5 seconds of total acquisition time as shown in [Figure 54](#). Note that we can also view the segmented decoded CAN serial data in the “lister” format, and we can also perform Search & Navigation operations on the captured segments.

39 Press the [**Serial**] front panel key; then press the **Lister** softkey.

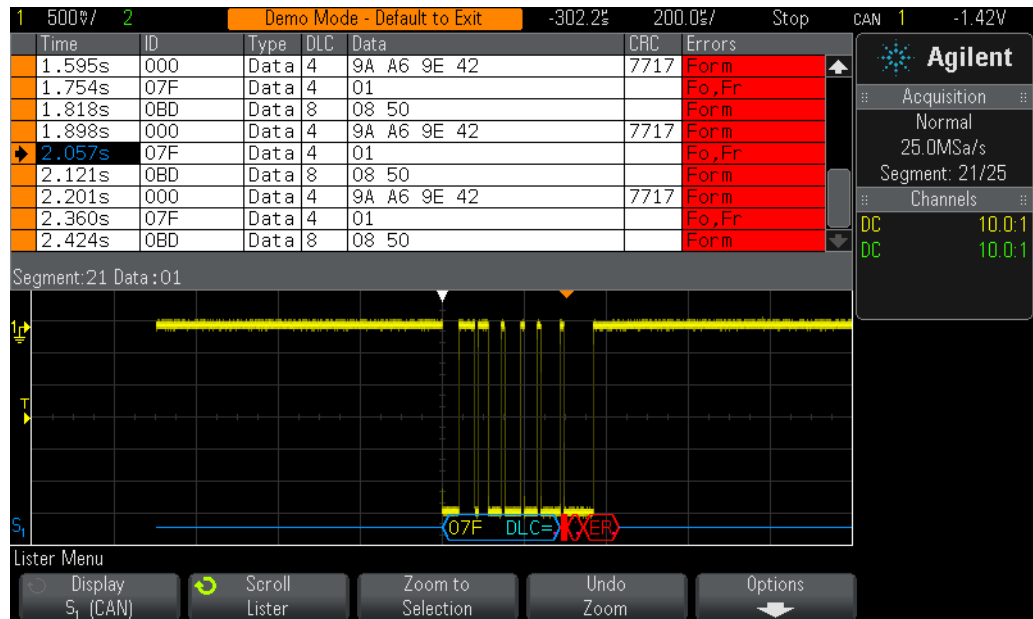

Figure 55 Lister display shows errors in every frame from a Segmented Memory acquisition based on triggering on “All Errors”.

Because we performed the Segmented Memory acquisition based on triggering on any “form” or flagged “error frame” condition (All Errors), our Lister display now shows that every captured frame contains some type of error as shown in [Figure 55](#).

Lab #14: Decoding, Triggering, and Searching on LIN Serial Bus Signals

In this lab you will learn how to set up the scope to decode and trigger on a LIN serial bus signal. In addition, you will learn how to use the scope's automatic LIN Search & Navigation capability, as well as Segmented Memory acquisition. This lab does not provide a tutorial on the LIN protocol and signaling, which is primarily used in automotive applications. To complete this lab, your scope must be licensed with the CAN/LIN trigger and decode option (Option AUTO). You can verify the installed options on your oscilloscope at [Help] > About Oscilloscope.

- 1 Connect the channel-1 probe to the Demo 1 terminal and ground.
- 2 Press [Default Setup] on the scope's front panel.
- 3 Press [Help]; then press the **Training Signals** softkey.
- 4 Using the Entry knob, select the **LIN** signal; then press the **Output** softkey to turn it on.
- 5 Set channel-1 to **500.0 mV/div**.
- 6 Set channel-1's offset/position to **+1.4 V**.
- 7 Push the trigger level knob to automatically set the trigger level to approximately **50%**.
- 8 Set the scope's timebase to **1.00 ms/div**.

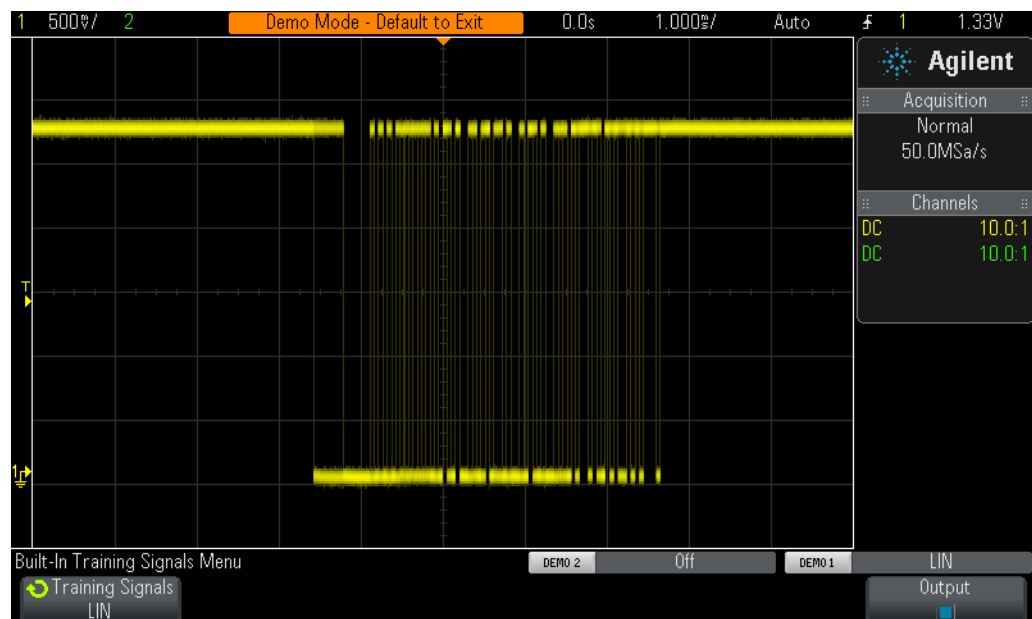

Figure 56 Capturing a LIN frame using the scope's Edge triggering mode.

You should now see on your scope's display what appears to be an un-triggered display of a digital burst signal similar to [Figure 56](#). Your scope is actually triggering on random rising edges of channel-1, which is the scope's default trigger condition. But this signal is too complex to establish a unique trigger point using simple edge triggering. This signal is a packet/frame of LIN serial bus traffic. Let's first set up the scope to intelligently decode this serial data stream based on the LIN protocol, and then we will establish a more unique trigger point using LIN triggering.

- 9 Press the **[Serial]** front key.
- 10 Press the **Mode I²C** softkey; then select the **LIN** serial decode mode using the Entry knob.
- 11 Press the **Signals** softkey and verify that the **Baud Rate** is set to **19.2 kb/s**.

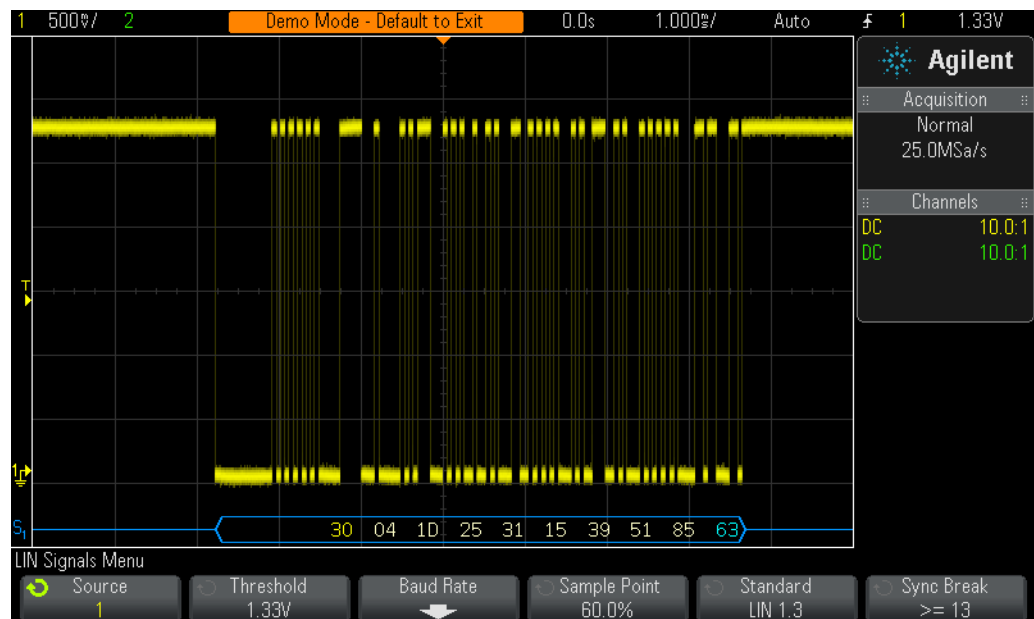

Figure 57 Decoding a LIN bus while triggering on any rising edge of the input signal.

You should now see LIN protocol decoding of this signal on your scope's display similar to [Figure 57](#), but we still haven't established stable triggering. The scope is still triggering on any rising edge of channel-1 (default trigger condition). Let's now set up the scope to trigger on a LIN frame with the ID = 21_{HEX}.

- 12 Press the **[Trigger]** front panel key.
- 13 Select **Serial 1 (LIN)** using the Entry knob.
- 14 Press **Trigger: Sync**; then select **ID – Frame ID** using the Entry knob.
- 15 Press the **Bits** softkey.
- 16 Press the **Frame ID** softkey; then set ID = **0x21** using the Entry knob.

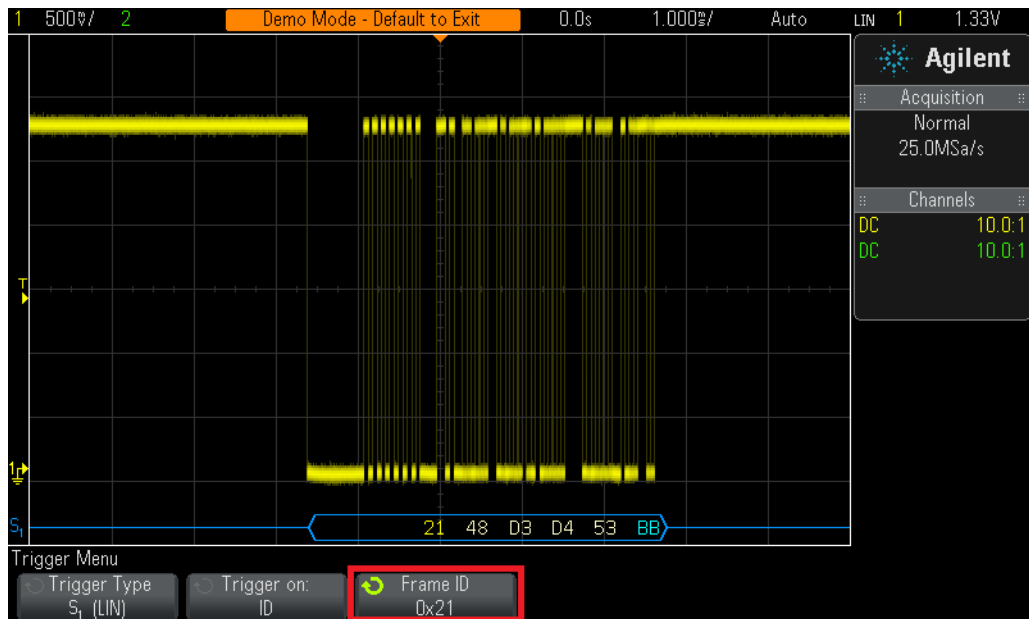

Figure 58 While triggering on LIN frame = 21_{HEX} , the scope’s hardware-based decoding reveals parity bit errors in the frame ID field.

Your scope should now be triggering on LIN frame = 21_{HEX} as shown in [Figure 58](#). With this scope’s very fast hardware-based decoding, you should also see that the frame ID field (left-most decoded byte) is sometimes displayed in red. This is an indication that the scope is capturing and quickly decoding infrequent parity bit errors. If the scope detects a checksum error, the last byte in the serial string (checksum byte) will be displayed in red. Note that Frame ID = 12_{HEX} contains an occasional checksum error. If you change to the trigger condition to trigger on ID = $0x12$, you can observe this particular type of error. Let’s now capture a very long stream of LIN traffic (2 seconds of acquisition time) and then manually search through the captured and decoded record.

- 17 Press the [**Serial**] front panel key.
- 18 Press the **Lister** softkey; then turn the Entry knob to select **Serial 1 (LIN)**.
- 19 Set the scope’s timebase to **200.00 ms/div**.
- 20 Press [**Run/Stop**] to stop repetitive acquisitions.
- 21 Press the **Scroll Lister** softkey; then turn the Entry knob to manually scroll through the lister table.

As you scroll through the data, note that waveforms “track”. This means that the frame that the arrow points to in the lister table corresponds to the waveforms that are positioned at center-screen. If you want to zoom in on a particular LIN frame of data, either push the Entry knob, or press the **Zoom to Selection** softkey. Looking for infrequent errors in this long

decoded record can be difficult. So let’s now perform an automatic search to find all occurrences of errors. We will then automatically navigate to each of these error conditions.

- 22 Push the horizontal position/delay knob to re-position the trigger point back to center-screen.
- 23 Set the scope’s timebase to **200.0 ms/div**.
- 24 Press the **[Search]** front panel key.
- 25 Press the **Search Edge** softkey; then select **Serial 1 (LIN)**.
- 26 Press the **Search for** softkey; then select **Errors** using the Entry knob.

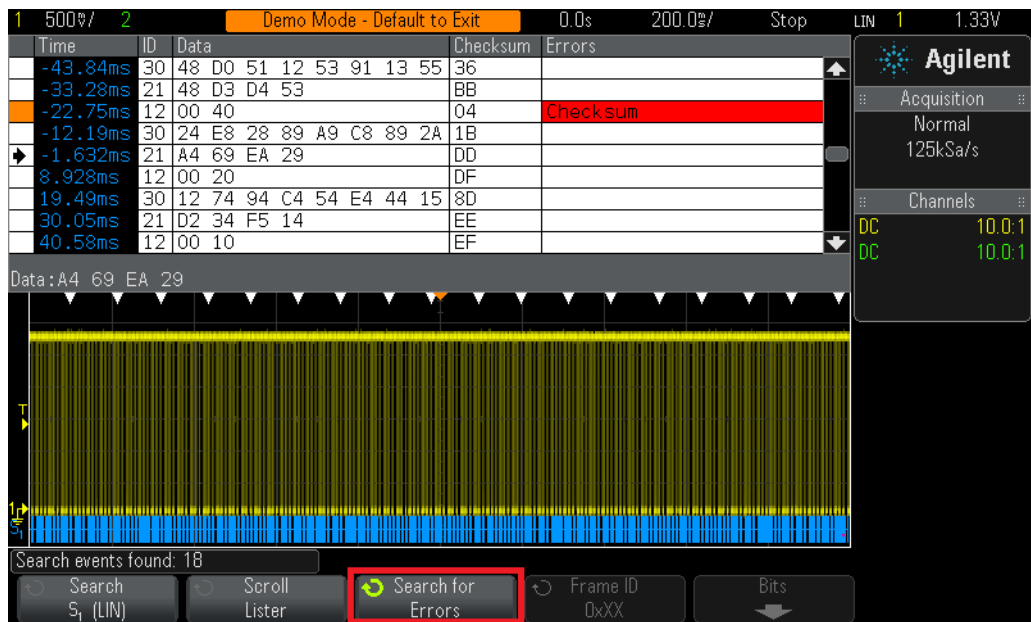

Figure 59 Using the scope’s automatic Search & Navigation capability to find all occurrences of LIN errors over a 2 second time span.

The white triangles near the top of the waveform area mark the time location of each “found” occurrence of our search operation as shown in [Figure 59](#). These frames are also marked in orange in the first/pointer column of the lister table. Your scope should have found and marked more than 15 occurrences of this search operation based on a total acquisition time of 2 seconds. Note that the number of “found” events is indicated near the bottom of the display. To automatically navigate to each LIN error, press the ⏪ and ⏩ front panel navigation keys.

Let's now use the scope's Segmented Memory mode of acquisition to capture 25 consecutive occurrences of the LIN frame that the scope is currently set up to trigger on (either ID = 21_{HEX} or ID = 12_{HEX}). But to complete the rest of this lab your scope must be licensed with the Segmented Memory option.

- 27 Push the horizontal position/delay knob to re-position the trigger point back to center-screen.
- 28 Set the scope's timebase to **1.00 ms/div**.
- 29 Press the **[Run/Stop]** front panel to begin repetitive acquisition again.
- 30 Press the **[Acquire]** front panel key.
- 31 Press the **Segmented** softkey; then turn the Entry knob to select **25** as the number of segments to capture.
- 32 Press the **Segmented** softkey to begin a Segmented Memory acquisition.
- 33 Press the **Current Segment** softkey; then turn the Entry knob to review all 25 captured segments.
- 34 Set the **Current Segment** to **25** and note the time-tag of the last captured segment.

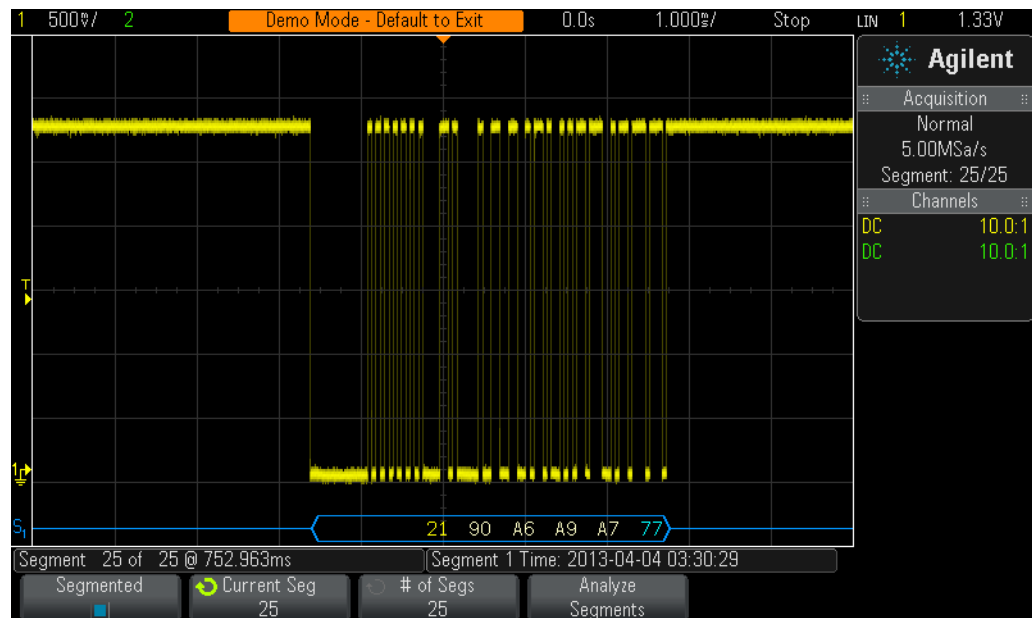

Figure 60 Using the scope's Segmented Memory acquisition to selectively capture 25 LIN frames of a specific ID.

Segmented Memory optimizes oscilloscope acquisition memory by only capturing important segments of a waveform based on the trigger condition and timebase setting. In this example, we have selectively captured approximately 750 milliseconds of total acquisition time as shown

in Figure 60. Note that we can also view the segmented decoded LIN serial data in the “lister” format, and we can also perform Search & Navigation operations on the captured segments.

35 Press the [Serial] front panel key; then press the Lister softkey.

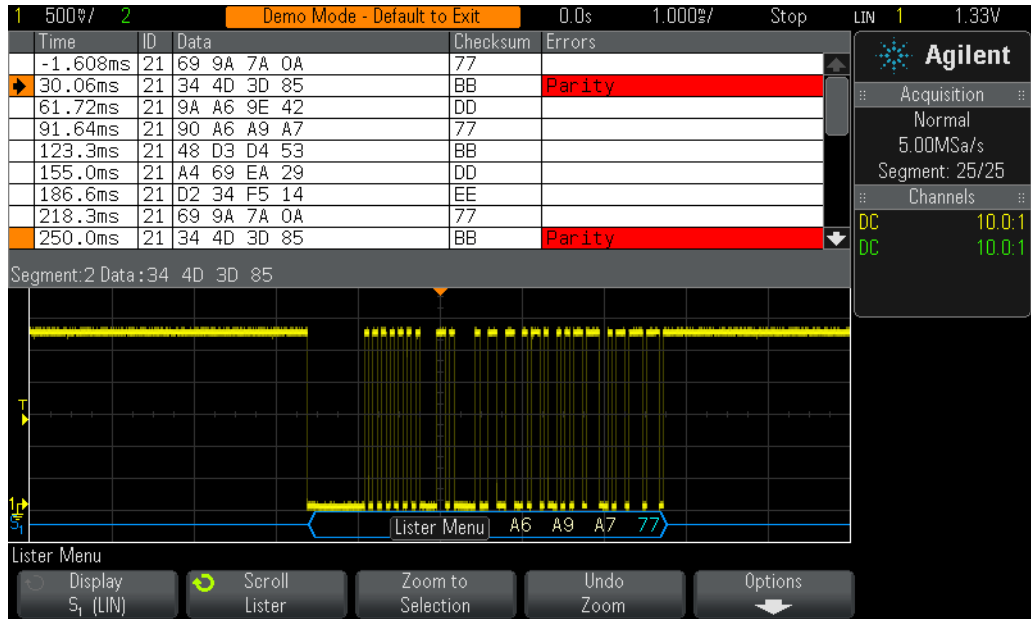
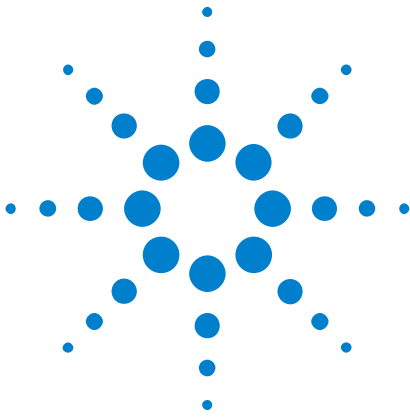

Figure 61 Lister display shows 25 consecutive occurrences of one particular LIN frame.

Because we performed the Segmented Memory acquisition based on triggering on LIN frame ID = 21_{HEX} (or perhaps you changed the trigger condition to trigger on ID = 12_{HEX}), our Lister display now shows a list of consecutive occurrences of just this particular frame ID as shown in Figure 61. To find out how often the parity bit or checksum errors occur during this particular frame, you could manually scroll through the list, or you could use the scope’s Search & Navigation capability to locate all occurrences of errors.



A Oscilloscope Block Diagram and Theory of Operation

DSO Block Diagram	88
ADC Block	88
Attenuator Block	89
DC Offset Block	89
Amplifier Block	89
Trigger Comparator and Trigger Logic Blocks	90
Timebase and Acquisition Memory Blocks	90
Display DSP Block	91



DSO Block Diagram

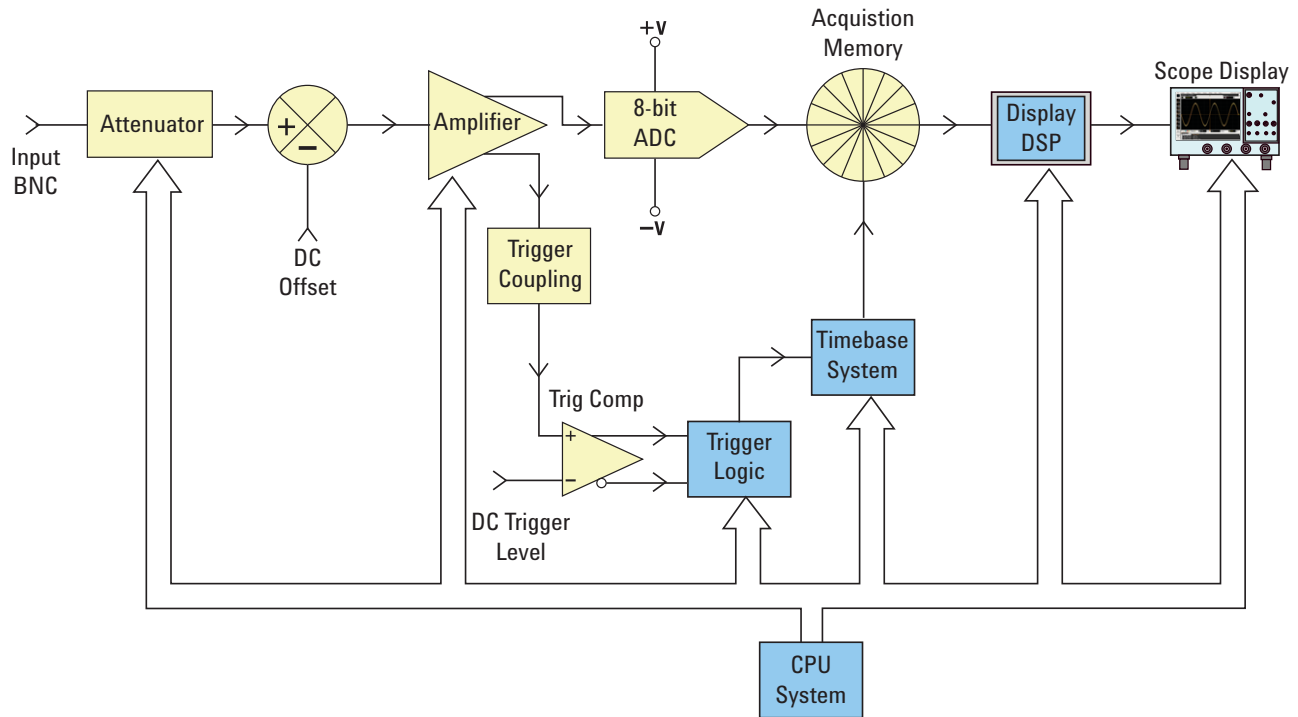

Figure 62 DSO block diagram

Figure 62 shows the block diagram of one channel of acquisition of a typical digital storage oscilloscope (DSO). The yellow-shaded blocks represent system components unique to a single channel of acquisition, such as Channel-1 or Channel-2. The blue-shaded blocks represent system components that are common among all channels of acquisition, such as the scope's common timebase and CPU system.

ADC Block

Shown near the middle of this block diagram is the analog-to-digital convertor (ADC). The ADC block is the core/central component of all DSOs. The function of this block is to convert the analog input into a series of digital words. Most of today's DSOs utilize 8-bit ADCs which will provide 256 unique digital output levels/codes. These digital binary codes are stored in the scope's acquisition memory, which will be discussed later. If the analog input level to the ADC is equal to or less than $-V$, then the output of the ADC will be 00000000 (0 decimal). If the analog input level to the ADC is equal to or greater than $+V$, then the output of the

ADC will be 11111111 (255 decimal). If the analog input level to the ADC is equal to 0.0 V, then the output of the ADC will be 10000000 (128 decimal).

To obtain the highest resolution and accurate measurements, the input to the ADC must be scaled within its dynamic range, which is $\pm V$. Although the ADC has a limited and fixed input dynamic range based on the ADC's reference voltages ($\pm V$), scopes must be able to capture a broad dynamic range of signals including both high level and low level input signals.

Scaling the ADC's analog input to be within the ADC's dynamic range is the combined function of the attenuator, DC offset, and amplifier blocks, which are discussed next.

Attenuator Block

The attenuator block is basically a network of resistor dividers used to scale the input signal to be within the dynamic range of the scope's variable gain analog amplifier and ADC. When inputting a high level input signal such as 40 V_{pp}, the signal level must be reduced (attenuated). If inputting a low level input signal such as 10 mV_{pp}, then the input signal is passed through to the amplifier with no attenuation (1:1). When you change the scope's V/div setting, you may hear audible clicking sounds. The clicking that you hear are mechanical relays switching-in different resistor divider networks. Note that the attenuator block also includes switching of the user-selectable input impedance (1 M Ω or 50 Ω), as well as AC or DC input coupling.

DC Offset Block

When inputting a signal with DC offset such as a digital signal that swings between 0V to 5V, if we want to display this signal centered on the scope's display, then an internal DC offset of the opposite polarity must be added to the signal in order to shift the input signal to be within the ADC's dynamic range. Alternatively, AC coupling can be selected to eliminate the DC component of the input signal.

Amplifier Block

The final analog processing stage to scale the input signal to be within the dynamic range of the ADC system is the scope's variable gain amplifier. If inputting a very low level input signal, you would typically set the V/div setting to a relatively low setting. With a low V/div setting the attenuator stage would then pass this signal straight through to the amplifier with no attenuation (gain =1), and then the amplifier would boost (gain >1) the amplitude the signal in order to take advantage of the full dynamic range

of the ADC. If inputting a very high level input signal, you would typically set the V/div setting to a relatively high setting. Using a high V/div setting, the attenuator stage would first attenuate the input signal (gain < 1) to get it within the dynamic range of the amplifier, and then the amplifier may further attenuate the signal (gain < 1) to get it within the dynamic range of the ADC.

Note that when you select a specific V/div setting, the scope automatically determines the required amount of attenuation in the attenuator block and the required amount of gain (or possibly additional attenuation) in the amplifier block. You can think of the attenuator block, DC Offset block, and amplifier block as a single block of analog input signal conditioning that linearly conditions a signal that is representative of the input signal to be within the dynamic range of the ADC block based on the V/div and offset setting of that particular channel of the scope.

Trigger Comparator and Trigger Logic Blocks

The purpose of the trigger comparator and trigger logic blocks are to establish a unique point in time on the input signal (or combination of multiple input signals) upon which to establish a synchronized acquisition.

Let's assume that your input signal is a sine wave and that you want to trigger acquisitions on the rising edge of the sine wave at the 50% level. In this case, the non-inverted output of the trigger comparator would be a square wave with a 50% duty cycle. If you set the trigger level above the 50% level, then the non-inverted output of the trigger comparator would be less than 50%. Alternatively, if you set the trigger level below the 50% level, then the non-inverted output would be greater than 50%. Assuming that triggering is to be based on just a positive edge crossing of a single channel, the trigger logic block would pass the non-inverted output of the trigger comparator to the timebase block. If you have selected to trigger on a negative edge crossing of a single channel, then the trigger logic block would pass the inverted output of the trigger comparator to the timebase block. The timebase block then uses the rising edge of the trigger signal as the unique synchronization point in time. Also note that triggering can be based on many other variables including time-qualification, as well as a combination of input signals from multiple input channels.

Timebase and Acquisition Memory Blocks

The timebase block controls when ADC sampling is started and stopped relative to the trigger event. In addition, the timebase block controls the ADCs sample rate based on the scope's available acquisition memory depth and the timebase setting. For example, let's assume that the scope has been set up to trigger at exactly center screen (default setting) using a

timebase setting of 1 ms/div. Let also assume for simplicity that the scope's acquisition memory depth is just 1000 points. Using these assumptions, the scope should acquire 500 points before the trigger event followed by acquiring 500 points after the trigger event. At this timebase setting, the scope will acquire 1000 points across a 10 ms time span (1 ms/div x 10 divisions). Even though the scope's maximum specified sample rate may be 2 GSa/s, at this timebase setting the timebase block will reduce the scope's continuous sample rate to 100 k samples/sec (Sample Rate = Memory/Time-span = 1000 samples/10ms = 100 kSa/s).

When the Run key is pressed, the timebase block enables continuous storing of digitized data into the scope's "circular" acquisition memory at the appropriate sample rate (100 kSa/s). While the timebase block increments addressing of the circular acquisition memory buffer after each sample, it also counts the number of samples taken up to 500 (assuming a memory depth of 1000 and also assuming triggering at center screen). After the timebase block determines that a minimum of 500 samples have been stored (meaning that at least half of the acquisition memory is full), the timebase block then enables triggering and begins to look for the first rising edge of the output trigger comparator (assuming simple edge triggering mode). While looking for the trigger event, acquisitions continue to be stored in the scope's circular acquisition memory buffer. If the trigger event is very infrequent, stored samples can actually be overwritten while waiting on the trigger event. But this is okay. Once the trigger event is detected, the timebase block then begins counting up to 500 again. When an additional 500 samples have been stored, the timebase block then disables (shuts down) sampling. This means that the last 500 stored samples represent sequential points on the waveform that occurred *after* the trigger event, while the previous 500 points represent sequential points on the waveform that occurred *before* the trigger event. At this point, operation is turned over to the Display DSP block.

Although we used an example of triggering at center-screen, using the horizontal delay/position control you can position the trigger point at any point. For example, if you adjust the delay such that the trigger point should occur at the 75% point along the horizontal axis (relative to the left side of the screen), then the timebase block would set the counter to initially store 750 points (assuming a memory depth of 1000 points) before enabling the trigger, and then capture an additional 250 points after detection of the trigger event.

Display DSP Block

Once an acquisition is completed, the Display DSP block then backs out the stored data from the acquisition memory block in a last-in-first-out sequence. Not only can the Display DSP block quickly perform digital signal processing on the stored data such as running a Sin(x)/x digital

A Oscilloscope Block Diagram and Theory of Operation

reconstruction filter, but it can also “pipeline” the stored and/or processed data into the scope’s pixel display memory. After the data has been “backed out” of acquisition memory, the DSP block then signals the timebase block that it can begin another acquisition.

Note that early generations of DSOs did not include an explicit Display DSP block. This function was traditionally handled by the scope’s CPU system, but with much lower efficiency that produced much slower waveform update rates. With custom display DSP processing, some of today’s DSOs can update waveforms as fast as 1,000,000 waveforms/second.

TIP

To learn more about the fundamentals of oscilloscopes, download Agilent’s application note titled *Evaluating Oscilloscope Fundamentals*. This publication is listed in "[Related Agilent Literature](#)" on page 101 with instructions on how to download.

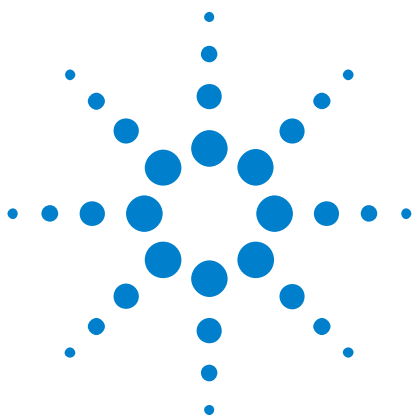

B Oscilloscope Bandwidth Tutorial

Defining Oscilloscope Bandwidth	93
Required Bandwidth for Analog Applications	94
Required Bandwidth for Digital Applications	95
Digital Clock Measurement Comparisons	98

Oscilloscopes have many different specifications that determine the accuracy that signals can be captured and measured. But the primary specification of an oscilloscope is its bandwidth. This tutorial on oscilloscope bandwidth will provide you some helpful hints on how to select an oscilloscope with the appropriate bandwidth for your digital and analog applications. But first, let's define oscilloscope bandwidth.

Defining Oscilloscope Bandwidth

All oscilloscopes exhibit a low-pass frequency response that rolls-off at higher frequencies as shown in [Figure 63](#). Most scopes with bandwidth specifications of 1 GHz and below typically have what is called a Gaussian frequency response. An oscilloscope Gaussian frequency response approximates a single-pole low-pass filter.



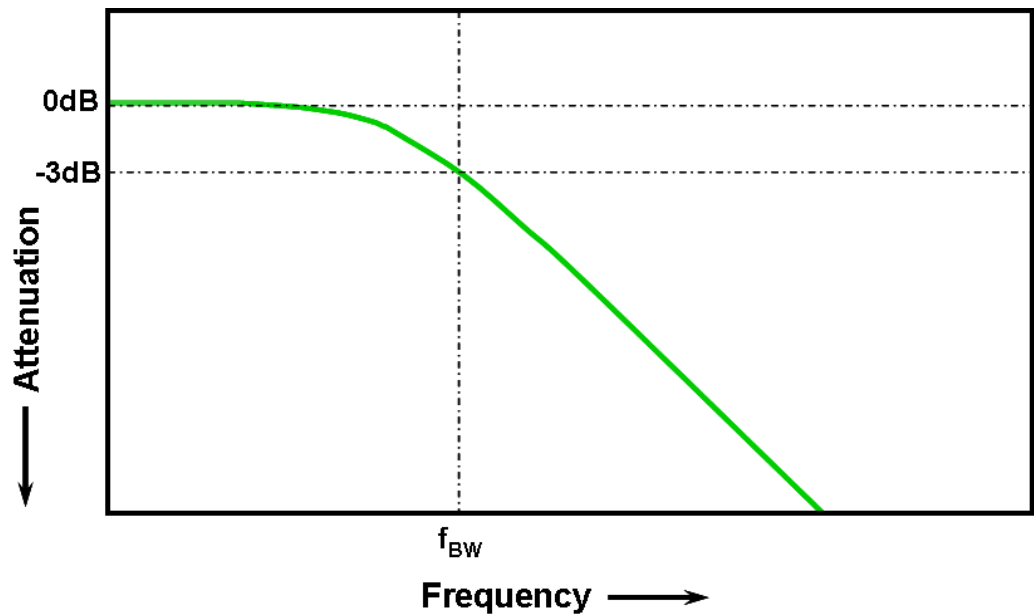

Figure 63 Oscilloscope Gaussian frequency response

The lowest frequency at which the input signal is attenuated by 3 dB is considered the scope’s bandwidth (f_{BW}). Signal attenuation at the -3 dB frequency translates into approximately -30% amplitude error. In other words, if you input a 1 Vp-p, 100 MHz sine wave into a 100 MHz bandwidth oscilloscope, the measured peak-to-peak voltage using this scope would be in the range of approximately 700 mVp-p (-3 dB = $20 \text{ Log } [0.707/1.0]$). So you can’t expect to make accurate measurements on signals that have significant frequencies near your scope’s bandwidth.

Closely related to an oscilloscope’s bandwidth specification is its rise time specification. Scopes with a Gaussian-type frequency response will have an approximate rise time of $0.35/f_{BW}$ based on a 10% to 90% criterion. But you need to remember that a scope’s rise time is not the fastest edge speed that the oscilloscope can accurately measure. It is the fastest edge speed the scope can possibly produce if the input signal has a theoretical infinitely fast rise time (0 ps). Although this theoretical specification is impossible to test – because pulse generators don’t have infinitely fast edges – from a practical perspective, you can test your oscilloscope’s rise time by inputting a pulse that has edge speeds that are 5 to 10 times faster than the scope’s rise time specification.

Required Bandwidth for Analog Applications

Years ago, most oscilloscope vendors recommended that your scope’s bandwidth should be at least three times higher than the maximum input signal frequency. Although this “3X” multiplying factor would not apply to

digital applications based on clock rates or edge speeds, it still applies to analog applications, such as modulated RF. To understand where this 3-to-1 multiplying factor comes from, let's look at an actual frequency response of a 1 GHz bandwidth scope.

Figure 64 shows a measured frequency response test (1 MHz to 2 GHz) on an Agilent 1 GHz bandwidth oscilloscope. As you can see, at exactly 1 GHz the measured output (waveform on oscilloscope display) is attenuated by slightly less than 3 dB ($V_o/V_i > 0.7$). To make accurate measurements on analog signals, you would need to use the scope in the portion of the frequency band where it is still relatively flat with minimal attenuation. At approximately one-third the scope's 1 GHz bandwidth, this scope exhibits very little attenuation (-0.2 dB).

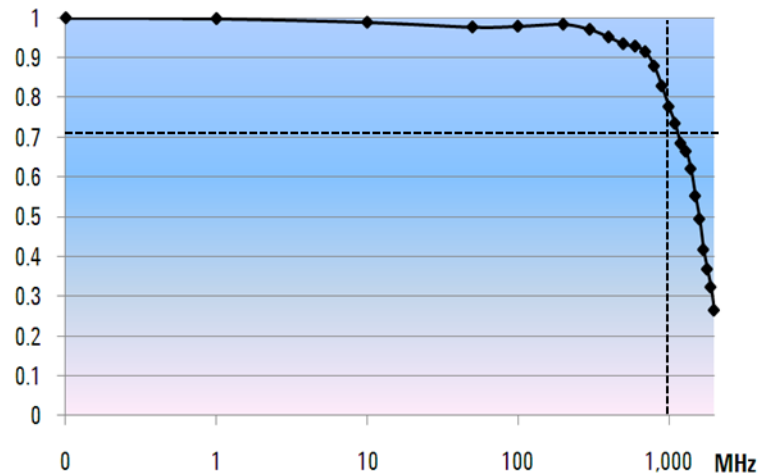

Figure 64 Actual frequency response of an Agilent 1 GHz bandwidth oscilloscope

Required Bandwidth for Digital Applications

Rule of Thumb

As a rule of thumb, your scope's bandwidth should be at least five times higher than the fastest digital clock rate in your system under test. If your scope meets this criterion, then it will be able to capture up to the fifth harmonic with minimum signal attenuation. This component of the signal is very important in determining the overall shape of your digital signals.

$$f_{BW} \geq 5 \times f_{clk}$$

But if you need to make accurate measurements on high-speed edges, this simple formula does not take into account the actual highest-frequency components embedded in fast rising and falling edges.

Step 1: Determine fastest actual edge speeds

A more accurate method to determine required oscilloscope bandwidth is to ascertain the maximum frequency present in your digital signals, which is not the maximum clock rate. The maximum frequency will be based on the fastest edge speeds in your designs. So the first thing you need to do is determine the rise and fall times of your fastest signals. You can usually obtain this information from published specifications for devices used in your designs.

Step 2: Calculate f_{knee}

You can then use a simple formula to compute the maximum “practical” frequency component. Dr. Howard W. Johnson has written a book on this topic, *“High-speed Digital Design – A Handbook of Black Magic.”*¹ He refers to this frequency component as the “knee” frequency (f_{knee}). All fast edges have an infinite spectrum of frequency components. However, there is an inflection (or “knee”) in the frequency spectrum of fast edges where frequency components higher than f_{knee} are insignificant in determining the shape of the signal.

$$f_{knee} = 0.5/RT \text{ (10\% 90\%)}$$

$$f_{knee} = 0.4/RT \text{ (20\% 80\%)}$$

For signals with rise time characteristics based on 10% to 90% thresholds, f_{knee} is equal to 0.5 divided by the rise time of the signal. For signals with rise time characteristics based on 20% to 80% thresholds, which is very common in many of today’s device specifications, f_{knee} is equal to 0.4 divided by the rise time of the signal. Now don’t confuse these rise times with a scope’s specified rise time. We are talking about actual signal edge speeds.

Step 3: Calculate scope bandwidth

The third step is to determine the oscilloscope bandwidth required to measure this signal, based on your desired degree of accuracy when measuring rise times and fall times. [Table 1](#) shows multiplying factors for various degrees of accuracy for scopes with a Gaussian frequency response.

Table 1 Multiplying factors to calculate required scope bandwidth based on desired accuracy

Required Accuracy	Require Bandwidth
20%	$f_{BW} = 1.0 \times f_{knee}$
10%	$f_{BW} = 1.3 \times f_{knee}$
3%	$f_{BW} = 1.9 \times f_{knee}$

Example

Let's now walk through this simple example:

Determine the minimum required bandwidth of an oscilloscope with an approximate Gaussian frequency response to measure a 1 ns rise time (10-90%)

If the signal has an approximate rise/fall time of 1 ns (based on a 10% to 90% criteria), then the maximum practical frequency component (f_{knee}) in the signal would be approximately 500 MHz.

$$f_{knee} = 0.5 / 1 \text{ ns} = 500 \text{ MHz}$$

If you are able tolerate up to 20% timing errors when making parametric rise time and fall time measurements on your signals, then you could use a 500 MHz bandwidth oscilloscope for your digital measurement applications. But if you need timing accuracy in the range of 3%, then a scope with 1 GHz bandwidth would be the better choice.

20% timing accuracy:
Scope bandwidth = $1.0 \times 500 \text{ MHz} = 500 \text{ MHz}$

3% timing accuracy:
Scope bandwidth = $1.9 \times 500 \text{ MHz} = 950 \text{ MHz}$

Let's now make some measurements on a digital clock signal with characteristics similar to this example, using various bandwidth scopes...

Digital Clock Measurement Comparisons

Figure 65 shows the waveform results when measuring a 100 MHz digital clock signal with fast edge speeds using a 100 MHz bandwidth oscilloscope. As you can see, this scope primarily just passes through the 100 MHz fundamental of this clock signal, thus representing our clock signal as an approximate sine wave. A 100 MHz scope may be a good solution for many 8-bit, MCU-based designs with clock rates in the 10 MHz to 20 MHz range, but 100 MHz bandwidth is clearly insufficient for this 100 MHz digital clock signal.

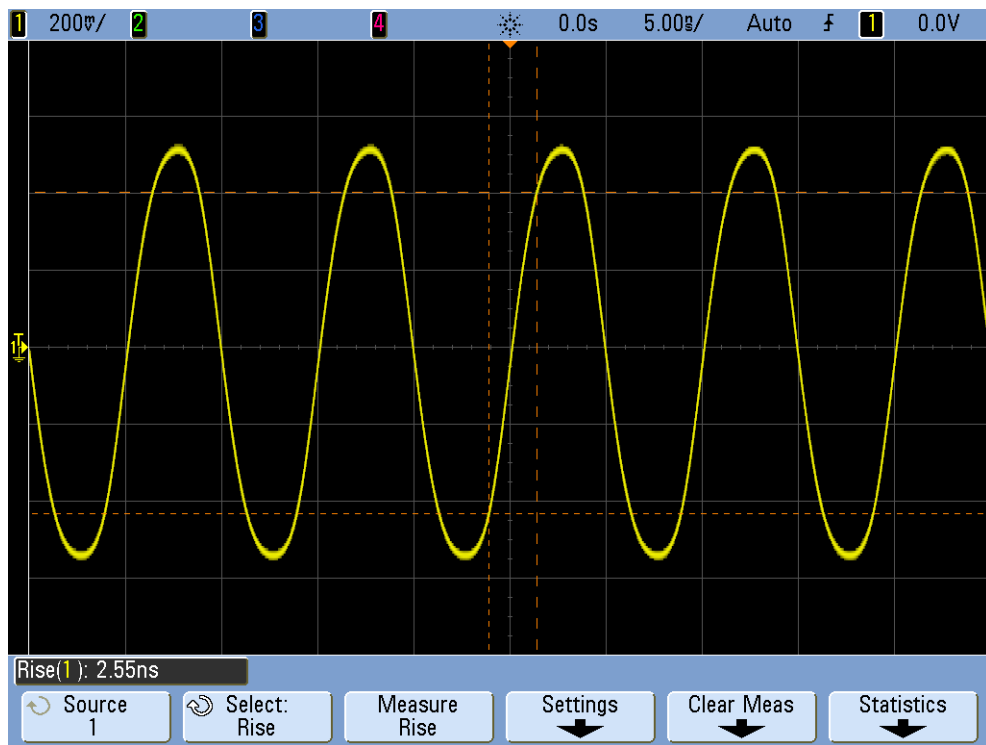

Figure 65 100 MHz digital clock signal captured on a 100 MHz bandwidth scope

Using a 500 MHz bandwidth oscilloscope, Figure 66 shows that this scope is able to capture up to the fifth harmonic, which was our first rule of thumb recommendation. But when we measure the rise time, we see that the scope measures approximately 750 ps. In this case, the scope is not making a very accurate measurement on the rise time of this signal. The scope is actually measuring something closer to its own rise time (700 ps), not the input signal's rise time, which is closer to 500 ps. We need a higher-bandwidth scope for this digital measurement application if timing measurements are important.

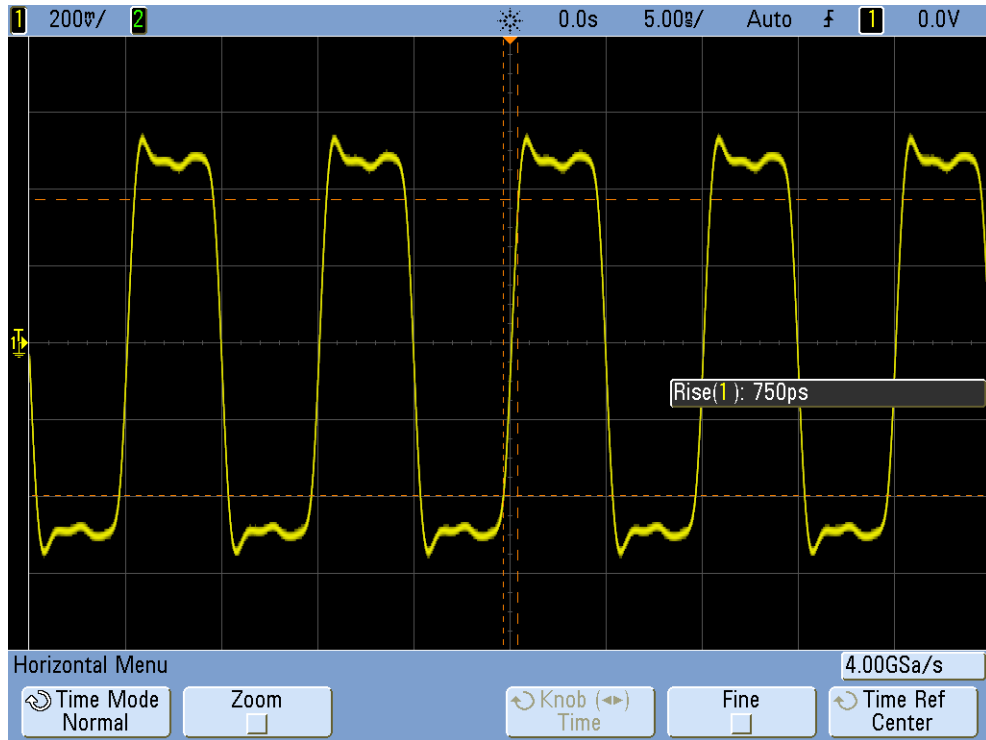

Figure 66 100 MHz digital clock signal captured on a 500 MHz bandwidth scope

When we use a 1 GHz bandwidth scope to capture this 100 MHz digital clock, the result is that we now have a much more accurate picture of this signal, as shown in [Figure 67](#). We can measure faster rise and fall times, we observe less overshoot, and we can even observe subtle reflections that the lower bandwidth scope masked.

B Oscilloscope Bandwidth Tutorial

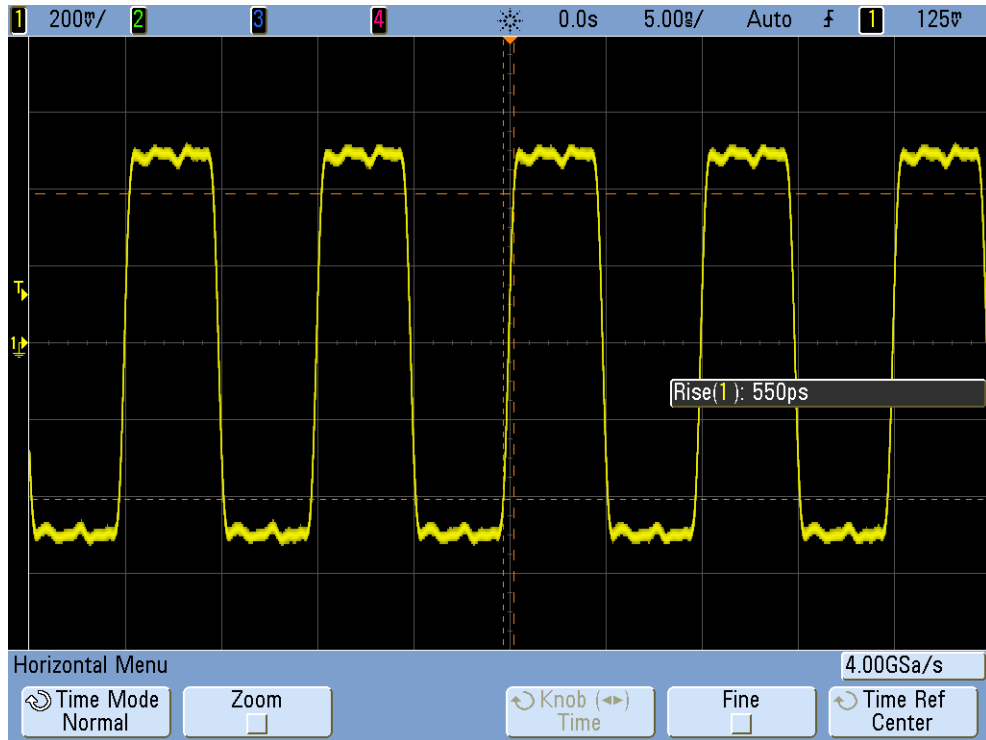
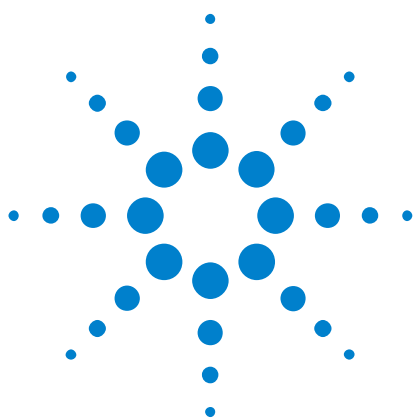

Figure 67 100 MHz digital clock signal captured on a 1 GHz bandwidth scope

This tutorial on oscilloscope bandwidth focused on oscilloscopes that exhibit a Gaussian frequency response, which is typical of scopes that have bandwidth specifications of 1 GHz and below. Many higher bandwidth oscilloscopes exhibit a frequency response that has a sharper roll-off characteristic. With this type of frequency response, in-band frequencies (frequencies below the -3 dB frequency) are attenuated less, while out-of-band frequencies (frequencies above the -3 dB frequency) are suppressed to a higher degree. This type of frequency response, which begins to approximate an ideal “brick-wall” filter, is sometimes called a “maximally-flat” frequency response. The formulas for computing required oscilloscope bandwidth on these higher bandwidth scopes (> 1 GHz) are different than what was presented in this tutorial guide. If you would like to learn more about oscilloscope bandwidth, you can download Agilent’s application note title, “*Evaluating Oscilloscope Bandwidths for your Application*”. This publication is listed in the “Related Literature” section of this document with instructions on how to download.

¹ High-Speed Digital Design, A Handbook of Black Magic, Howard Johnson, Martin Graham, 1993, Prentice Hall PTD, Prentice-Hall, Inc, Upper Saddle River, New Jersey 07458



C Related Agilent Literature

Table 2 Related Agilent literature

Publication title	Publication type	Publication number
Evaluating Oscilloscope Fundamentals	Application note	5989-8064EN
Evaluating Oscilloscope Bandwidths for your Application	Application note	5989-5733EN
Evaluating Oscilloscope Sample Rates vs. Sampling Fidelity	Application note	5989-5732EN
Evaluating Oscilloscopes for Best Waveform Update Rates	Application note	5989-7885EN
Evaluating Oscilloscope Vertical Noise Characteristics	Application note	5989-3020EN
Evaluating Oscilloscopes for Best Display Quality	Application note	5989-2003EN
Evaluating Oscilloscopes to Debug Mixed-signal Designs	Application note	5989-3702EN
Evaluating Oscilloscope Segmented Memory for Serial Bus Applications	Application note	5990-5817EN

To download these documents, insert the publication number in the URL:
<http://cp.literature.agilent.com/litweb/pdf/xxxx-xxxxEN.pdf>



C Related Agilent Literature

Index

Symbols

+Width measurement, 46

A

Acquire key, 7
Analyze key, 10
Auto Scale key, 7
automatic parametric measurements, 12, 14

C

CAN serial bus trigger/decode/search, 75
counter measurement, 26
cursors, 12

D

default setup, 6
Default Setup key, 7
Display key, 7
DSOXEDK, 5

E

Entry knob, 5

F

Fall Time measurement, 16
FFT (Fast Fourier Transform), 24
frequency measurement, 14, 26
front panel, 6

H

help on any topic, 6
hold-off, trigger, 40
Horiz key, 8
Horizontal Controls, 8

I

I2C serial bus trigger/decode/search, 54
import a mask, 37
Intensity key, 8

L

LIN serial bus trigger/decode/search, 81
literature, related Agilent, 101

M

manual cursors, 14
mask testing, 35
math operations, 23
Mode/Coupling key, 9
MSO (mixed-signal oscilloscope), 48

P

pattern trigger, 49
Peak Detect acquisition mode, 28
Pulse Width triggering mode, 44

Q

Quick Action key, 10

R

real-time sampling, 29
Rise Time measurement, 16
RS232/UART serial bus
trigger/decode/search, 67
Run Control, 7

S

sample rate, 27
sampling, 29
Segmented Memory acquisition mode, 30
Sigma quality factor, 36
Single key, 7
Snapshot-All measurement, 18
subtract waveform, 23

T

Tools Controls, 10
tracking cursor mode, 14
training signals, 5
Trigger Controls, 9
trigger hold-off, 40
Trigger Level knob, 9

U

Utility key, 10

V

Vbase measurement, 16
Vertical Controls, 9
Vmax measurement, 15, 16
Vmin measurement, 15, 16
Vp-p measurement, 14
Vtop measurement, 16

W

Waveform Controls, 7
waveform math function, 23

Z

Zoom display mode, 19
zoom key, 8

